



INSTALLATION INSTRUCTIONS

LEVITATE TRAVEL BAG

RIDE WITH US

Founded in 1981 and located in Northern Wisconsin, Show Chrome believes that everyone deserves convenience, safety, and style. All of our products are designed by riders for riders to achieve just that.

Our products are designed and engineered in the USA and 50% of our products are manufactured in the USA: your investment in us and our community.

Please let us know how we can make your ride even better. Our team of riders in Wisconsin answers every customer call - always has and always will.

Sincerely,

Your Show Chrome Team

Rice Lake, WI, USA

RIDE WITH CONFIDENCE

These instructions are for both riders and dealers - written as a step-by-step guide with an eye for detail, just like our products. It's all part of your experience with Show Chrome, and we take that seriously.

LET US KNOW!

Please review the instructions before diving in, and if things get uncomfortable, don't hesitate. Reach out to us. We're here to help and offer direct, human customer service based in Rice Lake, WI, USA at 888-244-2453 anytime M-F from 8-5 Central Time. Ride safely, and ride often.

FUN FACT!

The first-ever motorcycle, or rather motorized bicycle with an internal combustion engine, was made by Gottlieb Daimler and Wilhelm Maybach in Germany in 1885. It had a wooden frame and a gas-powered engine. It was destroyed in a fire in 1903.

PRODUCT INFO

Product:

Levitate Travel Bag

Part#:

H40-406BK

Fitment:

Universal

INCLUDED

- Levitate Travel Bag (1x)

TOOLS NEEDED

None

1

There are many ways you can enjoy your Levitate Travel Bag; here are the options:

- A. Mount it to your Show Chrome Ryker Levitate Bag Mount
- B. Mount it to most Ryker backrests
- C. Use it as a badass backpack in your everyday life

A**MOUNT TO SHOW CHROME RYKER LEVITATE BAG MOUNT # 41-427R****i**

Locate the rear slip pocket with webbing loop on the backside of the bag. [SEE FIGURES 1A - 1C]

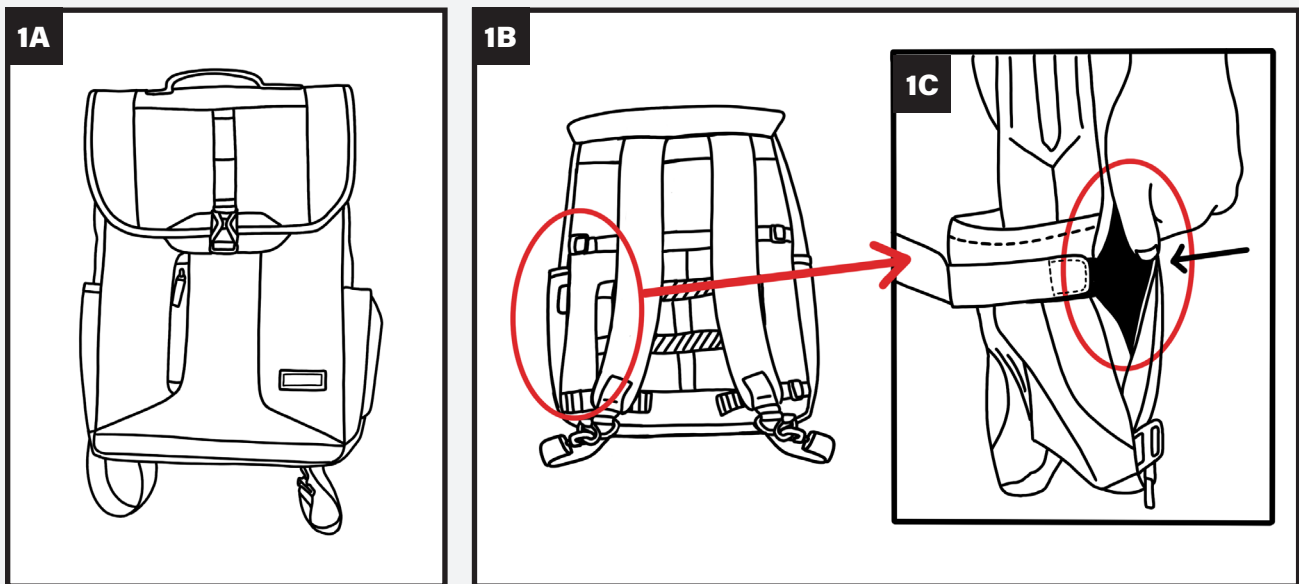

ii

(OPTIONAL) Unclip the adjustable shoulder straps and hide away in back panel pocket. [SEE FIGURES 2A - 2E]

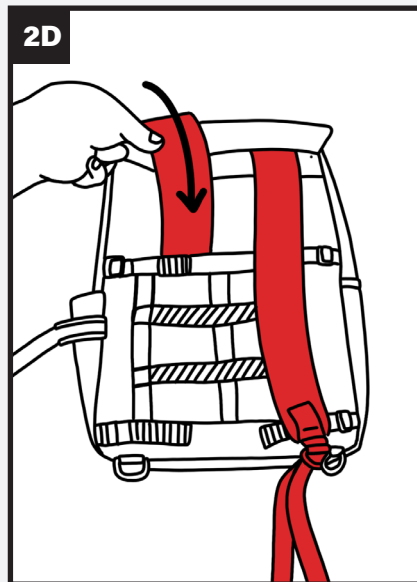
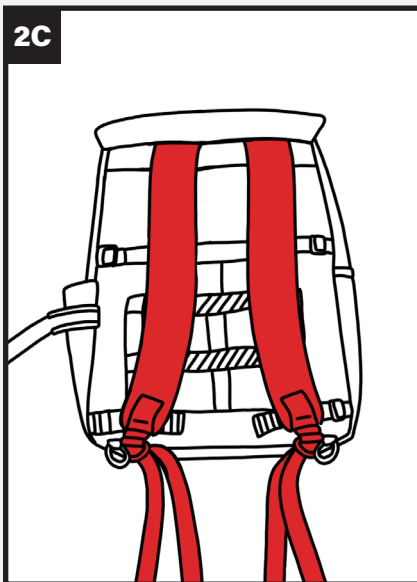
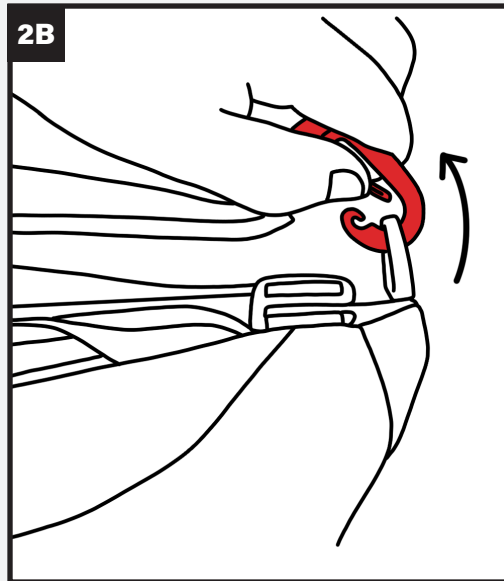
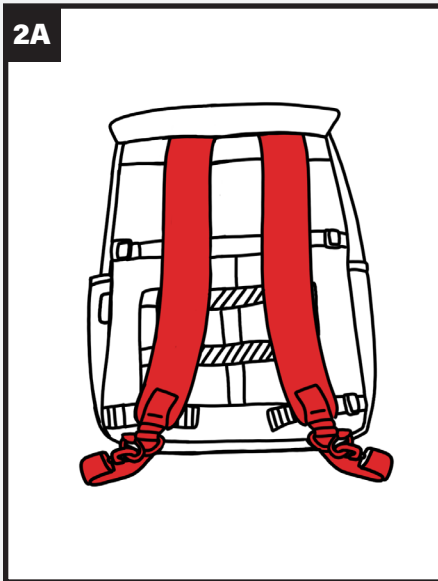

iii

Place the Levitate Travel Bag to Show Chrome's Ryker Levitate Bag Mount (Part #41-27R) by sliding the rear slip pocket to the mount. [SEE FIGURES 3A - 3C]

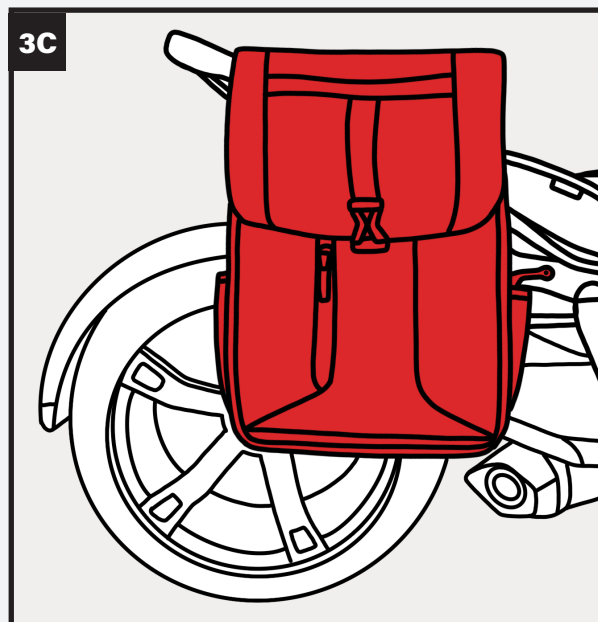
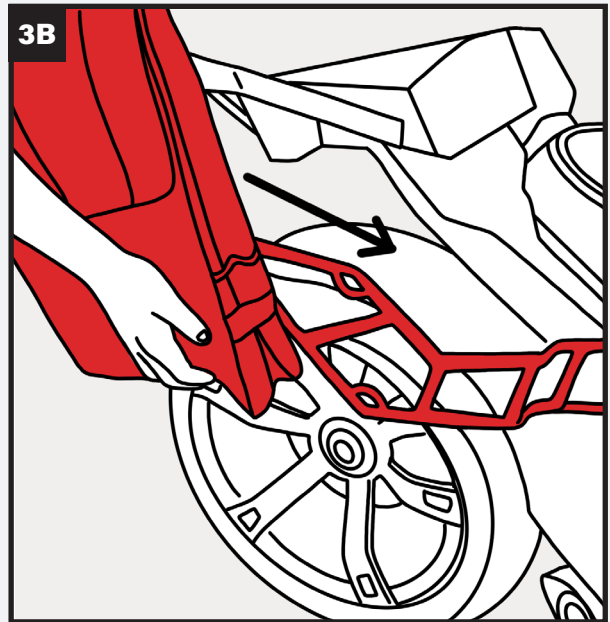
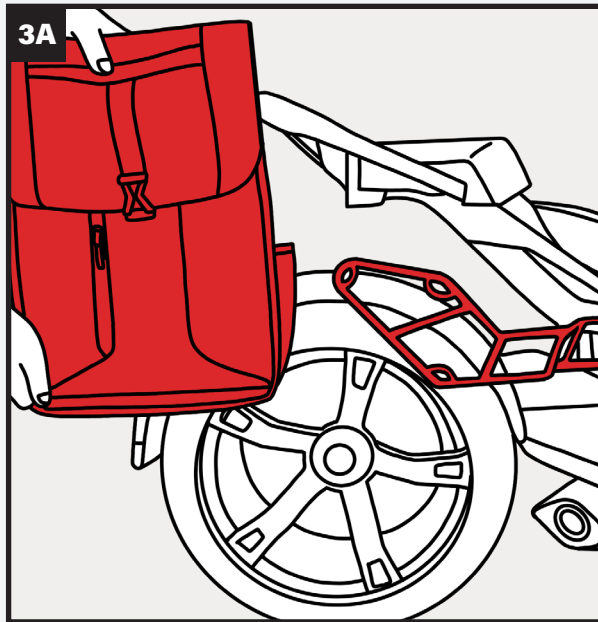

iv

Securely strap bag to mount using webbing loop.
[SEE FIGURES 4A -4C]

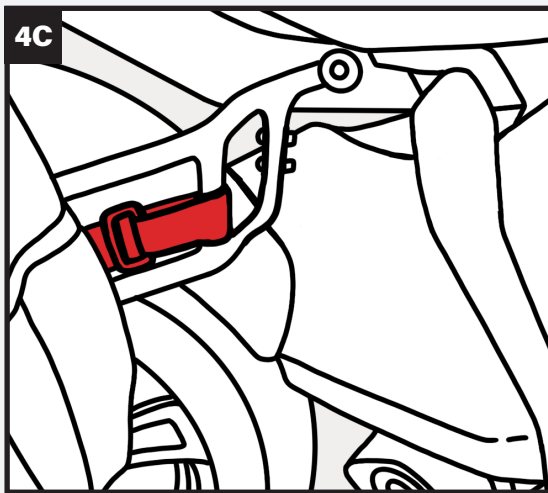
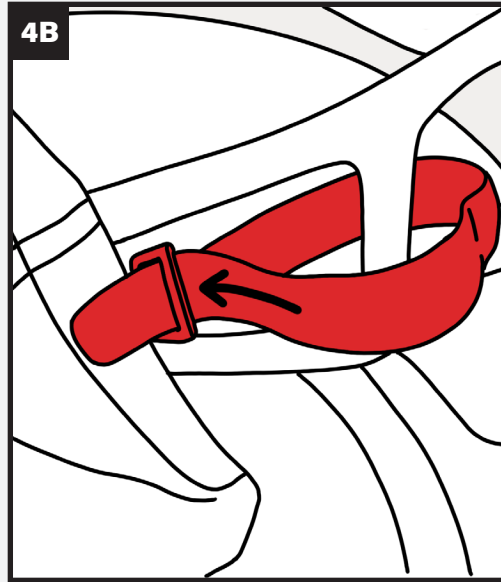
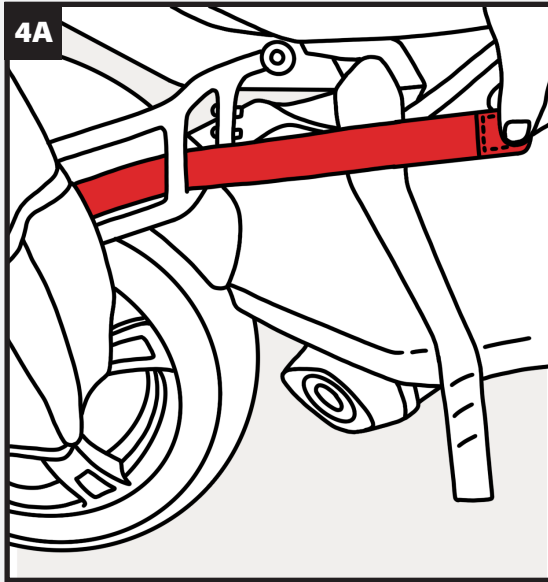
**iv**

When you're ready to remove your bag, repeat steps Aiii and Aiv in reverse order.

B

MOUNT TO MOST RYKER BACKRESTS

i

Locate the back panel pocket on your bag. [SEE FIGURES 1A & 1B]

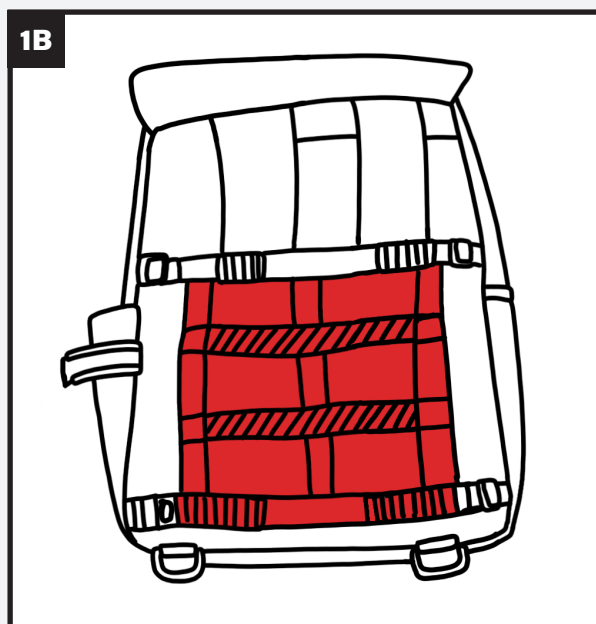
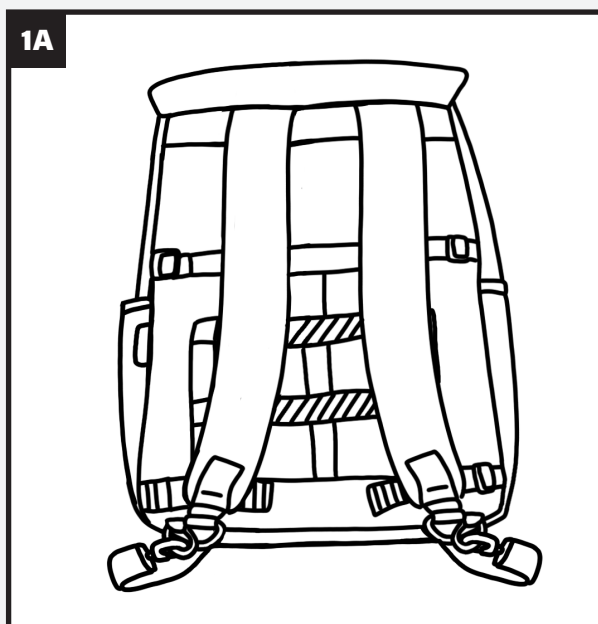

ii

Slide the bag to your chosen backrest. Adjust the straps to on the back panel pocket to snugly secure the bag. [SEE FIGURES 2A - 2D]

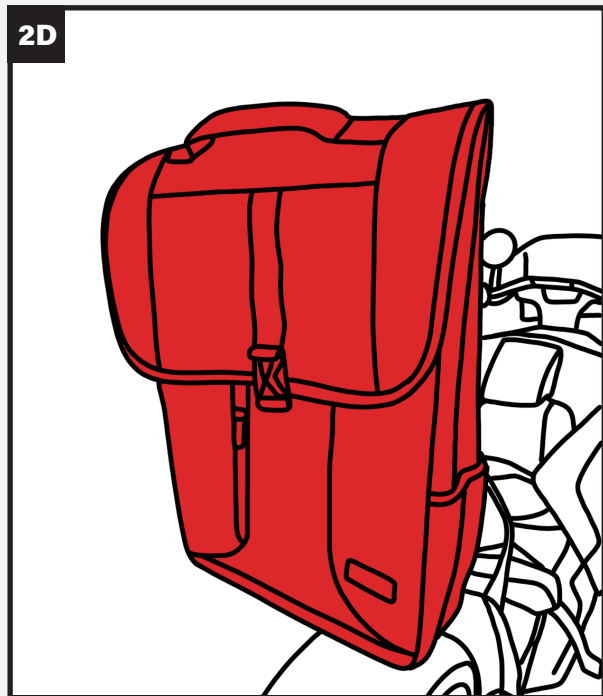
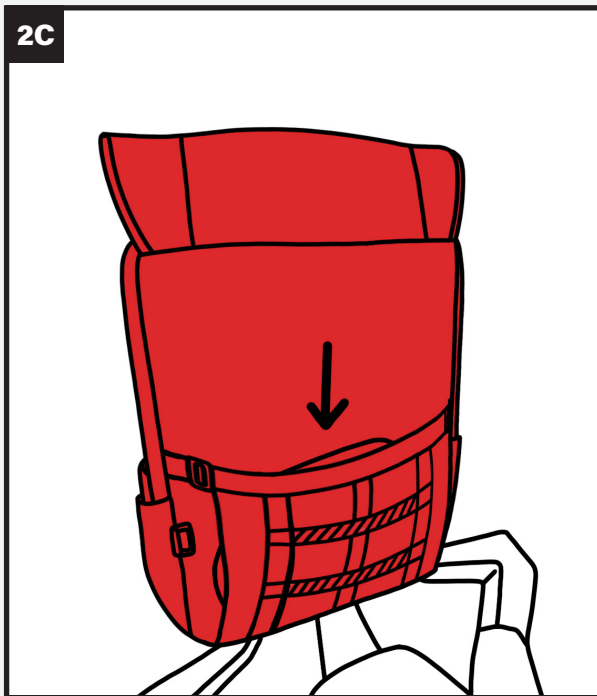
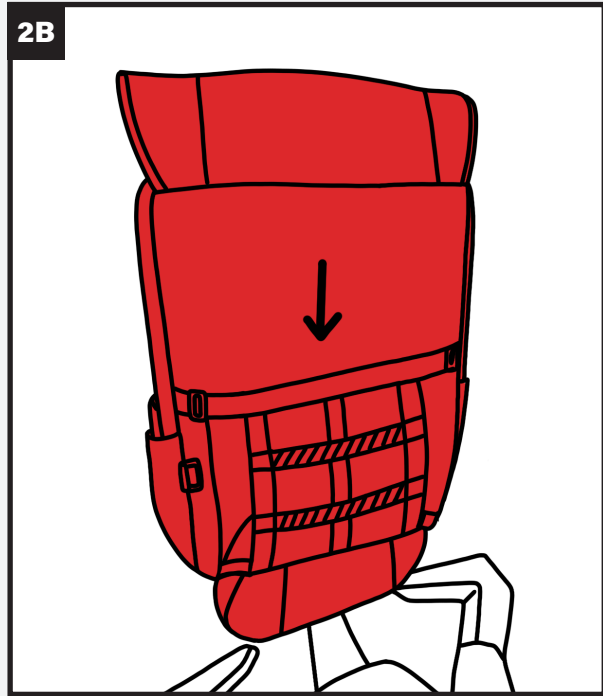
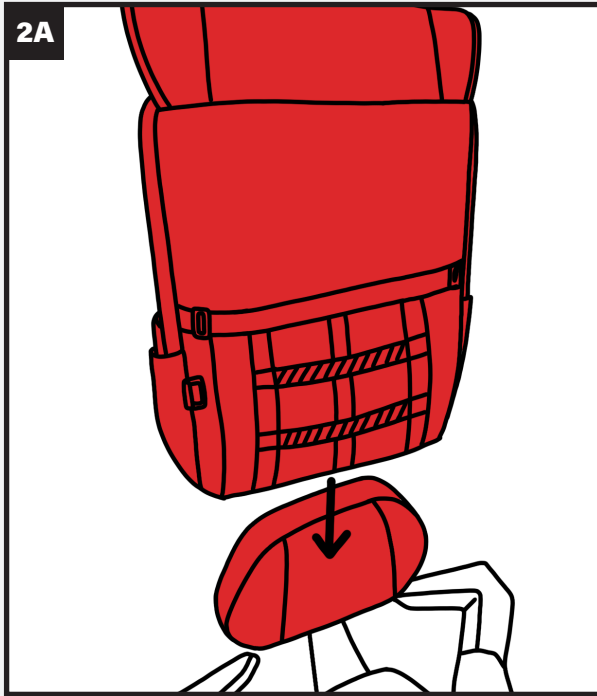

Reverse step Bii to easily remove the bag.

C

EVERYDAY BACKPACK

i

Simply use the bag on your everyday life to securely store your valuable items.
[SEE FIGURE 1A]



NOTICE

Ignoring the contents of these instructions may affect the product performance and functionality. Not following these instructions may cause damage to the product or to the vehicle to which it is being attached.



 1-888-244-2453

 www.showchromeusa.com