

# FOBO Bike 2

## User Manual

Version 2.0

(For iOS 12 and Android 5.0 or later)

# **Contents**

- 1** Introduction
- 2** About FOBO Bike 2
- 3** Importance of Tire Care
- 4** Product Description of FOBO Bike 2
  - 4.1** Tire Sensor Unit
  - 4.2** Sensor Lock Nuts & Wrench
- 5** Using FOBO Bike
  - 5.1** Installing FOBO Bike 2 App
  - 5.2** Installing FOBO Bike 2 Sensors
  - 5.3** Setting Up Multiple Users (FOBO Share)
  - 5.4** Disable, Release, Replace and Rotate Sensor
  - 5.5** Gauge Pressure
  - 5.6** User Profile Page
  - 5.7** How to Change the Theme Colour
  - 5.8** How to Change the Default Bike Image
  - 5.9** Overlay Services
  - 5.10** Reference Pressure
  - 5.11** Sensor Firmware Upgrade
  - 5.12** “Group Ride” Feature
- 6** FOBO Bike 2 Alert Messages
- 7** FOBO Bike 2 Sensor (TM1802) Specifications

- 8** Warning
- 9** Regulatory Information
- 10** Intellectual Properties
- 11** Limited Warranty and Disclaimer

# 1 Introduction

FOBO Bike 2 is a SMART Tire Pressure Monitoring System (TPMS) for every biker. With its patented technologies, it provides the following features/functions:

- View on demand tire pressure & temperature
- Monitors tire pressure in real time while riding or when in Bluetooth range
- Detects slow or fast leak and alerts users to anomalies.
- Sends instant audio, haptic and text alerts on a smartphone/smart watch/Bluetooth headset
- Easy to install without running wires, drilling holes, and tedious programming

FOBO Bike 2 uses Bluetooth 5.0 technology for connectivity to compatible smart phones and smart watches. With low power consumption of Bluetooth 5.0, the sensor is designed to last up to 1 year on a CR1632. **(NOTE: Battery life may vary according to usage and climatic temperature. Operating under extreme cold may drastically reduce battery life).** The TPMS also uses award winning automotive grade pressure sensor that is sensitive to finer pressure change than its predecessor.

Please ensure that your smartphone has Bluetooth Smart Ready (Bluetooth 4.0 or above) capability in order to use FOBO Bike 2. Currently FOBO Bike 2 works best with iOS 12 and Android 5.0 or later.

Before starting to use FOBO Bike 2, please download FOBO Bike 2 App onto your smartphone from Google Play Store or Apple AppStore.

FOBO Bike 2 is a product designed and produced by Salutica Allied Solutions Sdn. Bhd. (“Salutica”), a Malaysian company with its address at No. 3, Jalan Zarib 6, Kawasan Perindustrian Zarib, 31500 Lahat, Ipoh, Perak, Malaysia.

## 2 About FOBO Bike 2

FOBO Bike 2 monitors your bike tires non-stop around the clock. Most riders have encountered situations where they need to rush for an urgent appointment only to be stranded by a flat tire. A conventional Tire Pressure Monitoring Systems (TPMS) for bikes could not alert you in advance conveniently because it requires the use of a separate receiver. With FOBO Bike 2, you will get an alert as soon as the tire pressure drops below a certain pre-set level and as long as your smartphone is within the Bluetooth range (~30m) and App is running in the background. This alert gives you time to get the deflated tire fixed before you need to use your bike.

FOBO Bike 2 system consists of 2 sensors, and the FOBO Bike 2 App. It requires a compatible smartphone and the FOBO Bike 2 App for installation.

Replace your tire valve caps with the FOBO Bike 2 sensors and pair them according to the App's simple on-screen instruction.

**NOTE: Under certain conditions the signals from FOBO Bike 2 sensors may be blocked by surrounding objects or structures. If this occurs, please move around the vehicle in order to capture signals from all the sensors.**

The sensors will measure tire pressure of individual tires and transmit via Bluetooth to your smartphone. In the event of a problem with your tire pressure or temperature, the FOBO Bike 2 App on your smartphone will alert you. FOBO Bike 2 App can monitor concurrently up to 19 wheels. You will receive data from the tire pressure sensors for all your bikes through a touch of your finger.

If you would like to share your bike with family members or friends and ensure that are protected by properly inflated tires, you can allow others to access your FOBO Bike 2 sensors with permission through the Fobo Share function in a few easy steps. With Fobo Share, the other user (Sharee) just needs to download the FOBO Bike 2 App and get your authorization to receive alerts (if pressure or temperature is above or below the pre-set limits) and view pressure and temperature data on their own smartphones immediately.

**DISCLAIMER: FOBO BIKE 2 IS NOT A DEVICE THAT PREVENTS ACCIDENTS. IT IS ALSO NOT A DEVICE THAT PREVENTS TIRES FROM BECOMING DEFLATED OR OVERINFLATED. FOBO BIKE 2 IS NOT A SUBSTITUTE FOR SAFE TIRE MAINTENANCE PRACTICES. PLEASE CONTINUE TO TAKE PRECAUTIONARY MEASURES WHILE RIDING AND TAKE FULL RESPONSIBILITY OF YOUR VEHICLE'S TIRE CONDITION TO ENSURE SAFETY WHILE RIDING. YOU SHOULD CONTINUE TO PRACTICE PROPER TIRE CARE AND SCHEDULED TIRE MAINTENANCE.**

### **3 Importance of Tire Care**

It is extremely important to ensure bike tires are properly inflated for safety while riding. However, many riders tend to neglect proper tire care and maintenance. The bike tires are the only contact points between the bike and the road. The weight of the bike and rider are supported by the air pressure inside the tires. Improperly inflated bike tires may cause serious accidents on the road.

When bike tires are underinflated, a rider may feel instability while taking a corner or lack of response when maneuvering the bike. On top of that, underinflated tires reduce the bike's braking distance. The additional rolling resistance may cause build-up of heat which may lead to the de-lamination of the tire materials as well as damage to the tire's sidewall thus increasing the chances of a tire blow-out. Underinflated tires will also cause accelerated

wear on the tire and also uneven tire wear. Gas mileage will also be affected due to additional rolling resistance when riding with underinflated tires.

On the other hand, an overinflated bike tire will cause accelerated wear on the center portion of the tire resulting in uneven tire wear. It would also result in a harsher ride and makes the tire more susceptible to damage when going over potholes or debris on the road.

What is the optimum tire pressure? There are a lot of information about this subject in internet forums and web articles. A quick guide for better understanding of tire pressure below:-

- 1) Bike manufacturers recommend the optimum tire pressure for their bike models. They may recommend different tire pressure for front and rear tires so please follow the recommendation in the bike user manual. These recommended pressures usually meant for comfort riding and optimum performance of the bike. It is not advisable to go below the recommended pressure level.
- 2) The bike manufacturer recommended tire pressure is “cold pressure”. When you ride your bike to the gas station, the friction on the road will heat up your bike tires within a few minutes. Typically there will 1 psi (~7kPa) increase in air pressure for every 10 deg F (5.6 deg C) rise in temperature, and vice versa for decrease in air pressure. It is advisable to inflate the tire pressure with this compensated pressure above the recommended pressure.
- 3) Air pressure in tires is affected by changes in temperature. Check and adjust your tire pressure whenever there is a drastic change in environment temperature, e.g. change of seasons.
- 4) A tire will normally lose its pressure through natural causes unless accelerated by a puncture, faulty valve or damaged wheels. It is advisable to change the tire valves or at least check the valves condition every time you change a new set of tires. Under normal condition, a set of tires could deflate at a rate of up to 2 psi per month. It is good practice to check your tire pressure regularly and top up to the optimum pressure.
- 5) Every bike tire has a maximum inflation pressure. It is not advisable to inflate to the maximum inflation pressure of the tire. Follow the bike manufacturer’s recommended tire pressure instead.

## 4 Product Description of FOBO Bike 2

### 4.1 Tire Sensor Unit

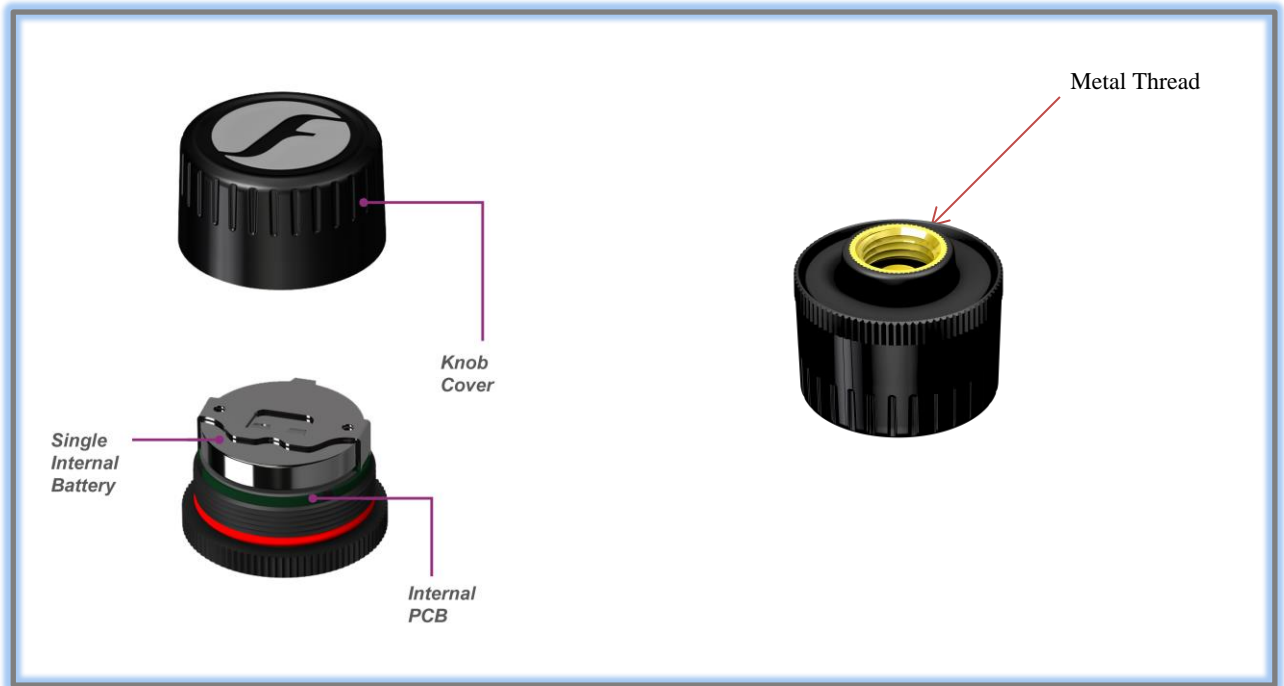

- |                         |  |
|-------------------------|--|
| Knob cover              | - Waterproof cover. Please ensure the red silicon ring is intact to prevent water from getting into electronics compartment.   |
| Single internal battery | - CR1632 coin cell battery. When replacing battery, please ensure the “+” sign of the battery is facing up, away from PCB.   |
| Internal PCB            | - Internal electronics circuit (The pressure sensor chip is mounted within this PCBA, and it senses the tire pressure against a built-in vacuum, resulting in an Absolute Pressure reading. The internal firmware will then subtract the sea-level pressure of 101.3 Kpa (14.7 psi) from this reading. This final reading which will be shown in the app can be termed as i) Tire <b>Absolute Pressure minus sea level pressure</b> , or ii) Gage Pressure reference to sea-level altitude. With this formulation, Fobo Bike 2 sensor will |

read the same pressure value for any given time, irrespective of altitude (assuming a constant temperature). This will ensure the correct tire footprint per vehicle manufacturer's pressure recommendation, for all altitude above sea-level, given a constant temperature.

As a corollary, a tire with a Fobo reading of, say 40 psi at an altitude of 5000ft, will read the same 40 psi when driven to sea-level, given a constant temperature. In reality, it will read higher due to the warmer temperature at sea-level, and may need some air release if the temperature difference is great. Tire pressure generally will increase 1 psi (~7kPa) for every 10 deg F (5.6 deg C) rise in temperature.

Fobo wishes to highlight the above formulation is for usage at sea-level and above, and will not be accurate for use otherwise. In practice, this should not be an issue as the lowest area on earth will result in an insignificant error of 0.3 psi (~2 Kpa).

For users who wish to retain 'Gage Pressure Reading', the Fobo Bike App has a Gage Pressure, adjusted to local altitude using cell towers or individual phone barometer if available.

FOBO Bike 2 sensor units are designed to be robust and operate reliably 24x7 to provide tire information around the clock. It is designed to be water proof (IP57) and by our special use of custom engineering plastics, it will be able to withstand road salts or other common automotive chemicals (petrol, engine oil, bike wash shampoo etc.).

Our designers have designed the sensors to ensure that there is no air leakage as it replaces the tire's original valve cap. There is no need to screw on the sensor extremely tight. Apply a reasonable hand twist force to ensure the sensor is securely installed and should be able to be removed by hand with ease.

Note that the sensor position is fixed during installation. When installing the sensors, please follow the on-screen prompt of the FOBO Bike 2 App. Do not screw on the tire sensors until instructed by the FOBO Bike 2 App. After installation, in the event the tire sensors positions are mixed up, usually after performing a tire rotation maintenance, you can easily re-position the sensors to their correct position by selecting 'Rotate Tires' on the FOBO Bike 2 App and follow the on-screen instructions. This eliminates the need to remove the tire sensors physically.



A missing or damaged sensor can be replaced easily, through the FOBO Bike 2 App. You will need to purchase a replacement sensor which you can do so online at [www.my-fobo.com](http://www.my-fobo.com).

**NOTE:** Battery life span up to 1 year is an estimate based on normal use at 23 °C. Battery life may vary according to usage and climatic temperature.

**Battery life span will change due to the following reasons:**

- 1) Frequent change of pressure threshold setting in the App.
- 2) Disabling & enabling of sensors.
- 3) Release & pairing.
- 4) Removal & screw-on of sensors.
- 5) Operating under extreme cold/hot temperature.
- 6) Testing of product.
- 7) Rotation.
- 8) Trigger alert or let activated alerts unattended.
- 9) Multiple removal and screw-on of sensors for equalizing all tire pressures.

All these activities will drain a battery very fast and affect the battery life span.

## 4.2 Sensor Lock Nuts and Wrench



FOBO Bike 2 sensors are tied to a FOBO account after installation. They are not reusable or transferable without the owner consent. This is a theft deterrent feature to discourage theft.

As an additional anti-theft feature, all FOBO Bike 2 package comes with lock-nuts and a special wrench. FOBO Bike 2 sensor functionality is not affected if you do not use the lock-nuts.

The lock nuts and wrench are made of custom engineering plastics that can withstand road salts and common automotive chemicals (gasoline, engine oil, bike wash shampoo, etc.).

In order to use the lock nuts, you must first install the lock nut to the tire valve (with the bump facing tire rim). Screw in the lock nut all the way down and ensure that there is still a **minimum of 5 thread count** on the tire valve for the sensor unit to be screwed on. If there is insufficient thread for the tire sensor, it may lead to air leakage. A solution for this would be to change the tire valve to one with a longer thread. Next, screw in the tire sensor unit until it is reasonably tight. Then use your finger to unscrew the lock nut outwards (i.e. anti-clockwise) until it pushes against the bottom of the sensor unit. Use the wrench to tighten the lock nut. The resultant friction force will make it difficult to remove the sensor unit without loosening the lock nut. Hold the valve stem with one hand and tighten the lock nut with the wrench on another hand. This is to avoid the valve from twisting making it unable to tighten the lock nut.

**WARNING:** Do not apply too much force to tighten the lock-nut. You may face difficulty to loosen the lock nut.

**NOTE:** If your tire valve is too short, you shouldn't use the lock nut as this will block the sensors from being completely screwed on the tire valve and causes air leak. Our sensors are designed to work on a tire valve with a minimum of 5 thread counts.

Use the key chain provided to keep the wrench together with your bike keys, so that you don't have to worry about misplaced wrench when you need to remove the sensors when refilling air to your tires.

**It is recommended to apply some soap water (on the tire valve installed with FOBO Bike 2 sensor) after installing a sensor in order to check for any leakage.**

# Step by Step Diagram How to Use FOBO BIKE 2 Lock-Nut and Wrench

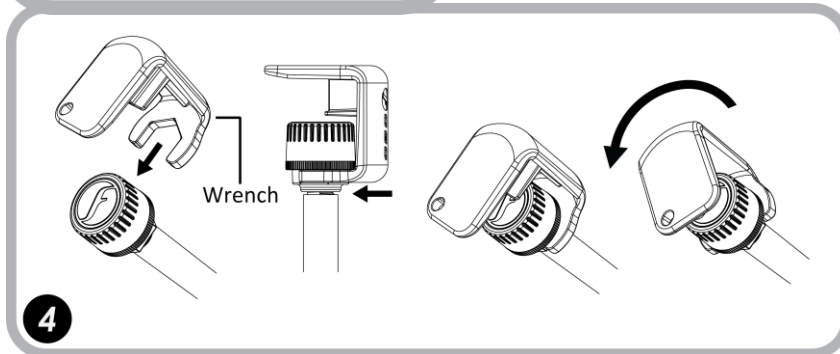
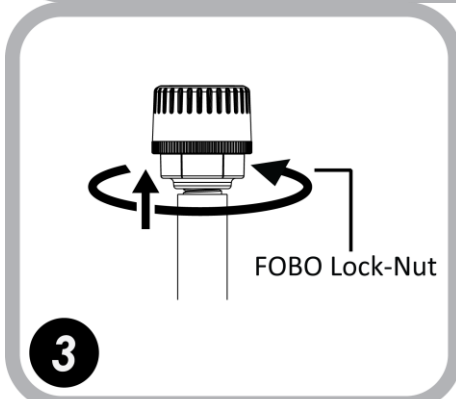
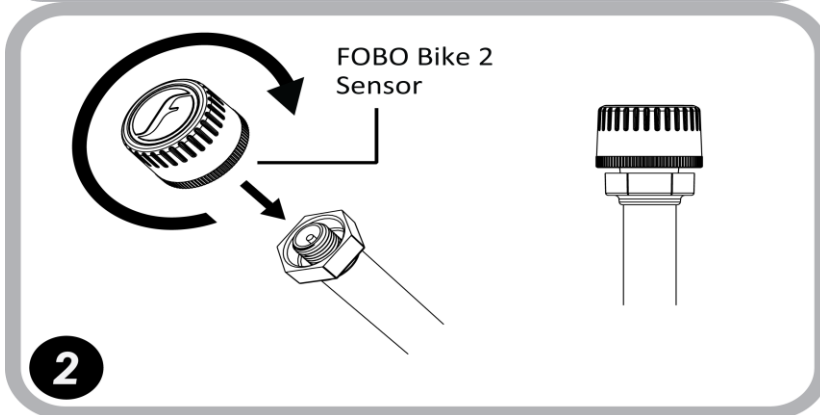
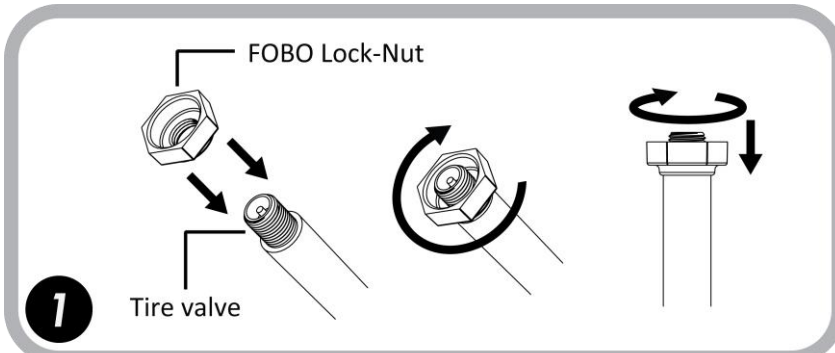

## 5 Using FOBO Bike 2

### 5.1 Installing FOBO Bike 2 App

You are required to have a smartphone with **Bluetooth 4.0** (Bluetooth Smart) capability in order to use FOBO Bike 2. The smartphone also must be running on iOS 12 and Android 5.0 or later. Follow the steps below to install FOBO Bike 2:-

**Step 1:** Download FOBO Bike 2 App onto your smartphone

- For iPhone users, download from Apple's AppStore. For Android users, download from Google Play store. Search for "FOBO Bike 2".

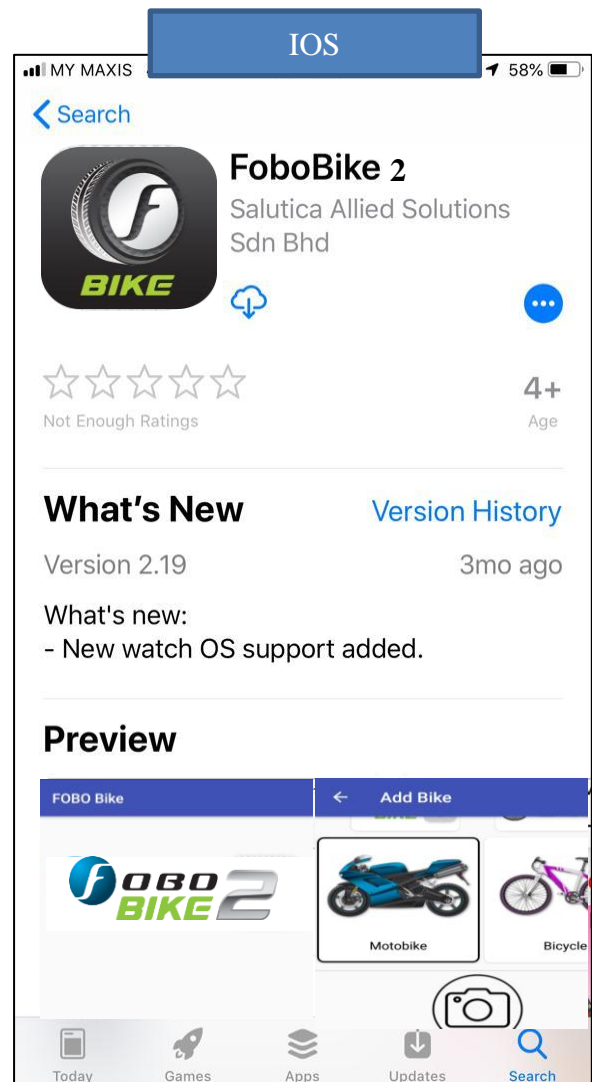
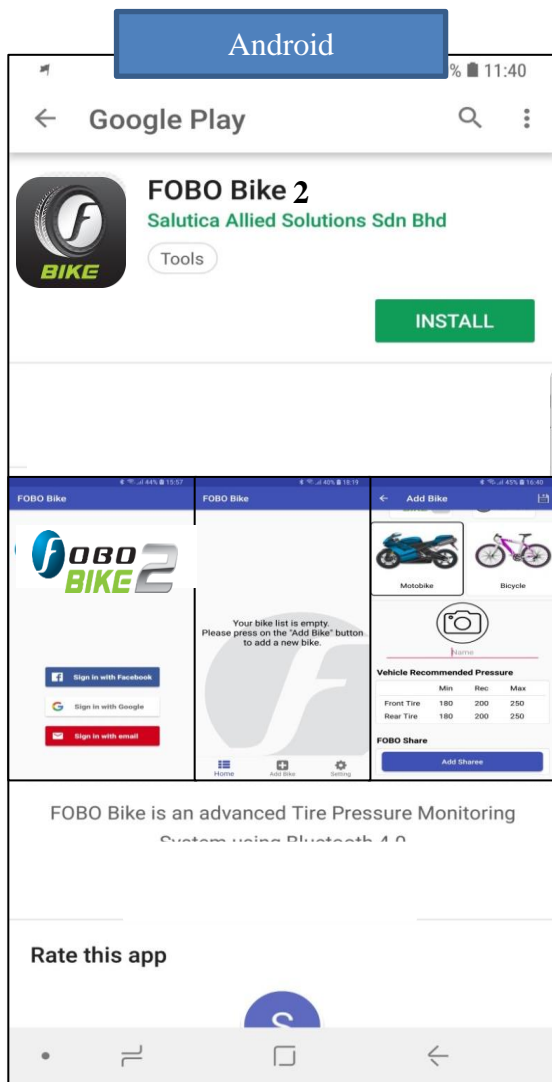

**Step 2:** Launch FOBO Bike 2 App and sign in using Facebook, Google or your personal email address.

**f** **FOBO**

**Welcome to FOBO Bike 2**  
Please enter your login credentials.

Email

Password

**LOGIN**

Or

Sign in with Google

Sign in with Facebook

Sign in with Apple

[Forgot Password?](#)

Don't have an account? [Create](#)

Pictures shown are for illustration purpose only

Follow the below steps if you choose to login using “Sign in with email”:

- Click on “Sign in with email”.
- Key in your email, First name & surname, Password and click save.
- You will be brought to the FOBO Bike 2 App’s Home screen.

**Note:**

- Please remember the password you entered while creating an account. You can click on “Trouble signing in” option on sign in page to get instructions on how to reset password.
- If you do not receive any email (to reset password) from FOBO Admin after 15 minutes (with a good internet connection), please write in to [fobo@salutica.com.my](mailto:fobo@salutica.com.my). FOBO representative will be in touch with you to solve the issue.

**IMPORTANT:**

FOBO Bike 2 sensors are locked to your FOBO account as an anti-theft deterrent. Stolen sensors cannot be used by anyone else other than the FOBO account owner.

Location service is required to be enabled for the FOBO Bike 2 App (FOBO Bike App does not use the GPS function to track your location). The location service on the iOS/Android system has other functionality that the FOBO Bike 2 App uses to operate properly. It will ensure FOBO Bike 2 functions as designed, mainly for alert functions, and also for the gauge pressure feature to work as required by users living at high altitudes. FOBO Bike 2 is designed to be a low energy system and does not drain your smartphone battery excessively.

By submitting your information to sign up as a new user account, you acknowledge your acceptance to the terms and conditions of our Software Licensing Agreement and Privacy Policy.

## 5.2 Installing FOBO Bike 2 Sensors

**NOTE:**

Do not install the sensors to the bike tire valves until prompted by the FOBO Bike 2 App's on screen instruction.

To minimize the risk of potential electrostatic discharge (ESD) attack, please hold the tire rim when screwing the sensors on to the tire valves. ESD may cause damage to the sensor or impair its function.

Installing FOBO Bike 2 sensors on more than one bike which are closely parked may cause cross interference to the Bluetooth signals. Please install FOBO Bike 2 on one bike at a time.

## **WARNING!**

**Please ensure sufficient clearance between installed FOBO Bike 2 sensor and any part of the bike. There is a risk of damage to the sensor or ripping off valve from the rim or sudden air leak if clearance is insufficient; the valve may deflect under strenuous vibration.**

Ensure sensor clearance with vehicle parts is 10 mm (3/8”) and 3 mm (1/8”) for installation on a rubber valve and a metal valve, respectively. **(For metal valve only, the most definitive test is to push the motorcycle which has been installed with the sensors for a short distance forward or backward to ensure that the closest part such as the brake caliper does not knock or touch the mounted sensors.)**

**RUBBER VALVE:** FOBO strongly recommends use of sensors with only metal valves as many as user finds that it is difficult to determine the fitness conditions of rubber valves. Use of sensors with rubber valves can cause a leak of tire blowout which it turns leads to sudden loss of control of the vehicles that subsequently leads to an accident and serious injuries. If user chooses to use rubber valves, users must regularly check if the valves are fit to use. FOBO is not liable for any untoward consequences.

We highly recommend using Metal valves; T-valves and short metal valves are available on our web-store. Follow the below link to purchase:

<https://my-fobo.com/accessories>



To begin using FOBO Bike 2, firstly ensure that the FOBO Bike 2 App is downloaded, and you have already login to the App ([see section 5.1 above for installation and login](#)).

Follow the steps below to pair FOBO Bike 2 to your smartphone:-

- 1) Turn on your smartphone's Bluetooth and internet connection.
- 2) Open FOBO Bike 2 App.
- 3) Allow all the permissions when prompted by the App.
- 4) Click on Add Bike button "+" on the FOBO Bike 2 App Home page to add a bike to your account.

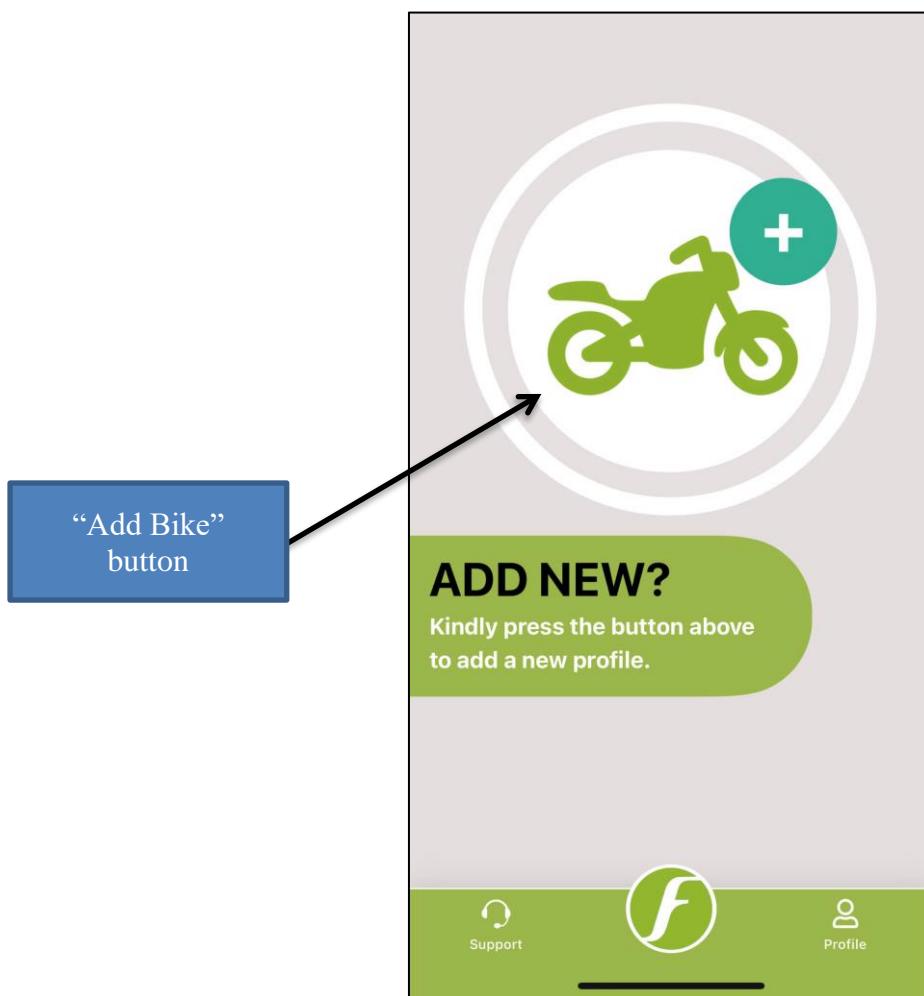

5) Choose type of bike profile then press “Next”.

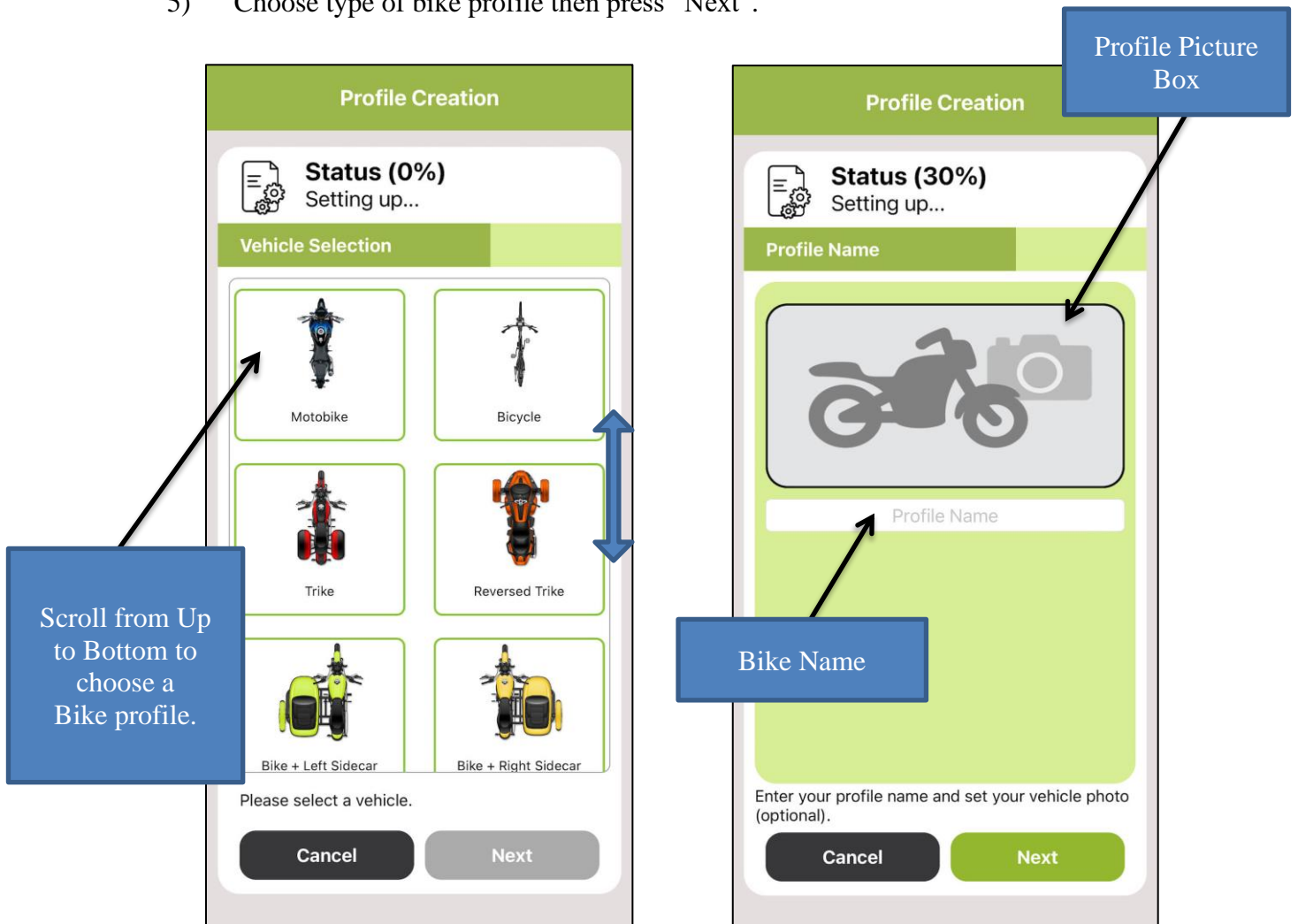

6) Tap on the profile picture box and take a picture of your bike or choose from the Gallery (optional).

7) Key in the name you would like to identify your bike, then press “Next”.

- 8) Select bike manufacturer recommended tire pressure. You may refer to the bike owner’s manual for the recommended tire pressure. Press the “Next” button to proceed to the “Vehicle Details” page or you may press “Skip All” to enter the information at later time.

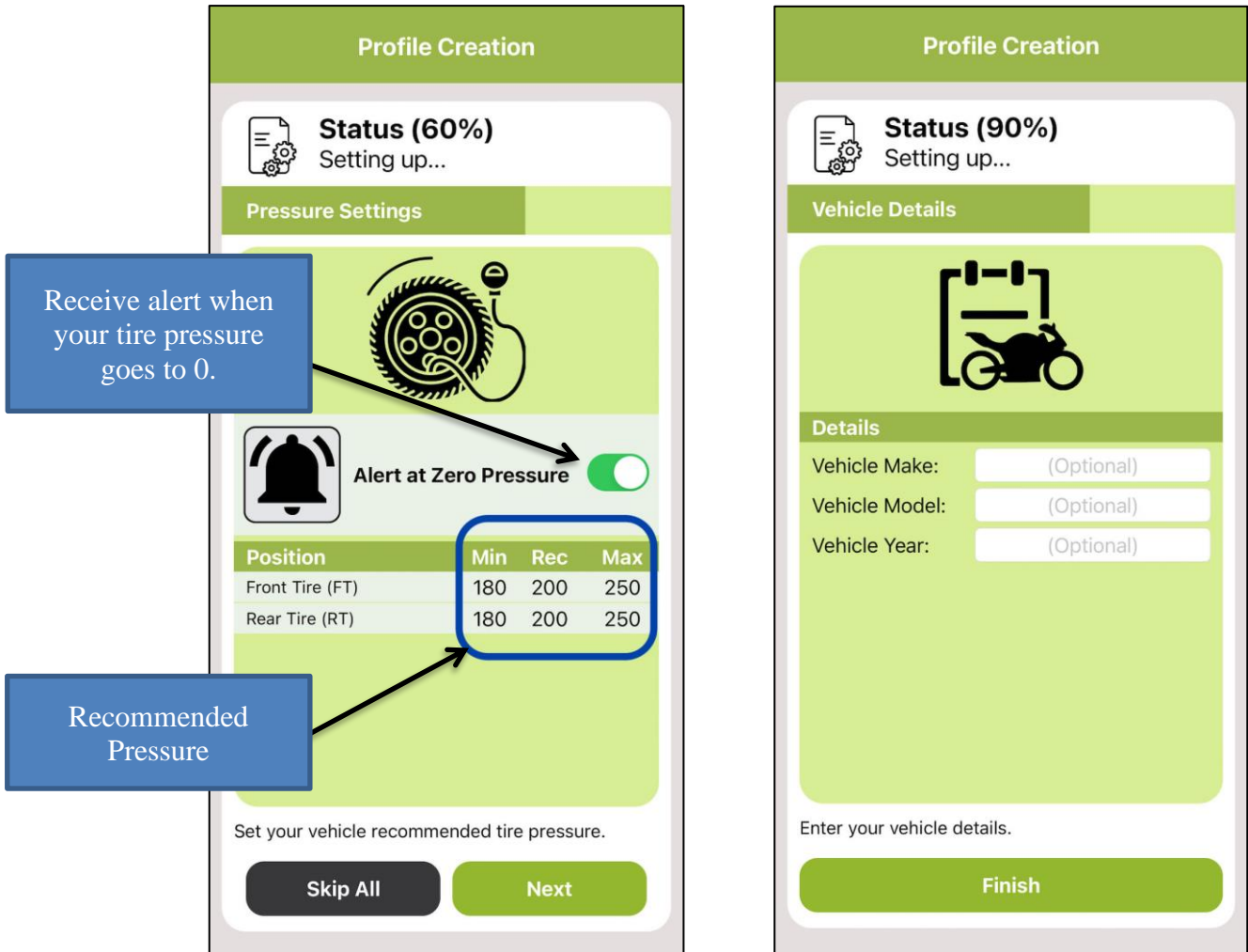

- 9) At the “Vehicle Details” page, you may enter the “Make”, “Model” and the “Year” information of your vehicle. Press the “Finish” button to complete the profile creation process.

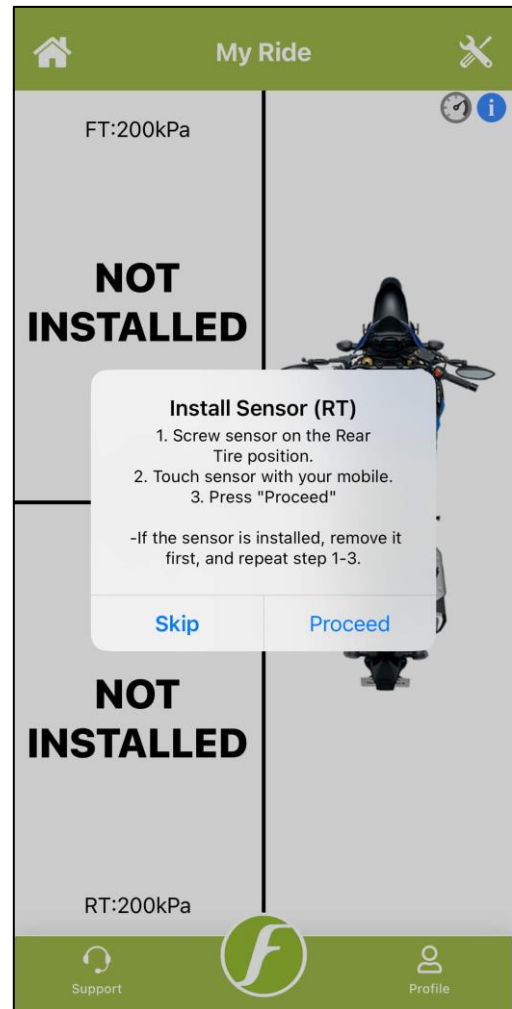

- 10) Click on the bike profile, you will be prompted to install sensor. Follow the instruction on the screen. Screw FOBO Bike 2 sensor on to tire valve only when you are prompted. Make sure your smartphone is nearby or touching the sensor to detect signal from the sensor unit. If you had screwed in the sensor before instructed by the App, remove the sensor completely and screw it back in again. Keep other sensors far while installing a sensor on tire valve.



**CAUTION:**

Motor vehicles of all kinds (cars, trucks, motor scooters and motorcycles) come with a very wide array of rims, wheels, and tires, with an even larger choice of aftermarket products. It is impossible for us to test every combination and check the fitment of the FOBO sensor. In some instances, when the FOBO sensor is screwed onto the valve stem, it might extend slightly beyond the face of the rim/wheel. If the rim/wheel comes close to or strikes an object, such as a curb, a pothole, the guide rail for an automatic car wash, or a component on the vehicle (such as the brake system on a motorcycle), the FOBO sensor or the valve stem itself might become damaged. This can cause the FOBO to provide improper readings, or might cause a loss of air pressure. We recommend that you carefully assess the fitment of your rims, wheels, tires and the FOBO on your vehicle. If you have any concerns, consult with your tire shop or auto mechanic. A shorter valve stem might be considered to mitigate the situation.

## 5.3 Setting Up Multiple Users (FOBO Share)

FOBO Bike 2 is easy to share with your family members and friends. You can share FOBO Bike 2 with up to 100 users by using the App's Fobo Share function. All that is required is that these other persons download the FOBO Bike 2 App (they will also need an iOS/Android smartphone with Bluetooth 4.0 that is running on iOS 12 and Android 5.0 or later) on their smartphone and activate the account.

Follow the below steps to share your FOBO Bike 2 with other users:-

1. Ensure that the user to be shared (recipient) has downloaded the FOBO Bike 2 App and activated the account.
2. Ensure that the recipient's smartphone has Bluetooth and internet connection turned on.
3. On your bike status screen, click on the settings icon.

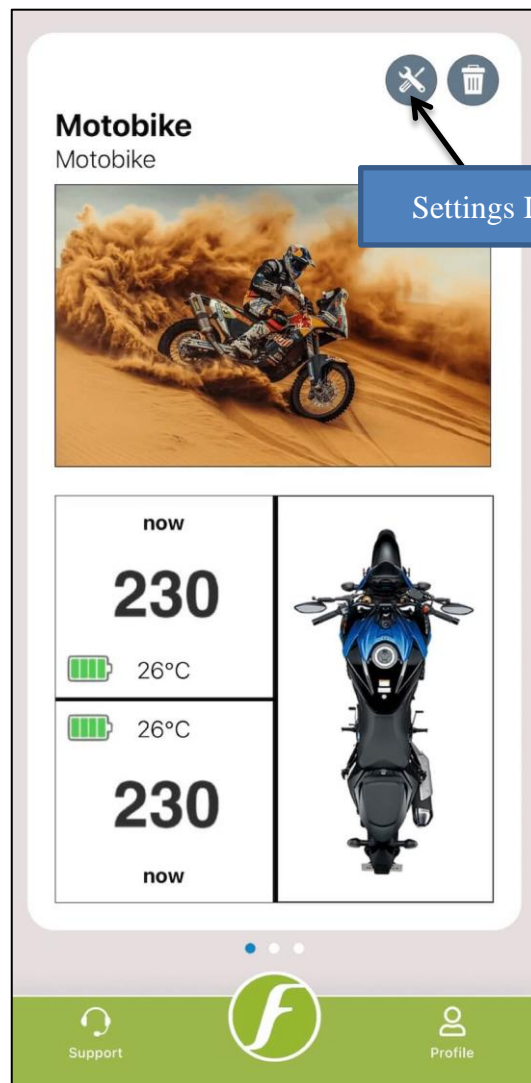

4. Click on the “Add Sharee” button and complete the action by using any of the available option.

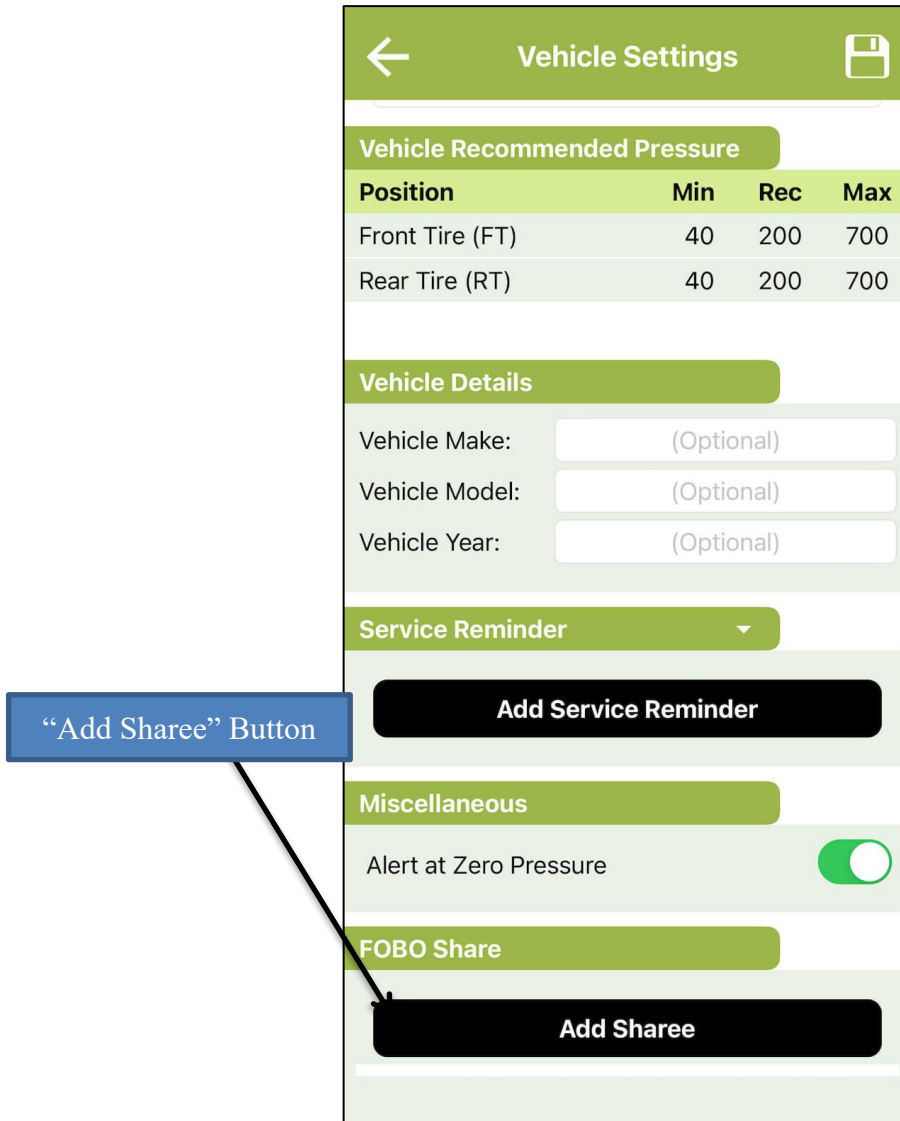

5. Once recipient clicks on the link, the shared profile will appear on his/her smartphone under FOBO bike 2 App. Sharee will start to receive all the data from shared FOBO Bike 2 sensors on his/her smartphone; when he/she (sharee) or Master is within the Bluetooth range of the sensors.

6. Sharee Email will appear under Master Account on the “Bike setting” page.



**NOTE:** Please ensure good Internet connection for FOBO Bike 2 App to connect to the FOBO cloud server.

Note that shared users will not be able to change settings (name, Pressure limits, etc.) on your FOBO Bike 2 profile using their smartphones. They can only view the readings. At the FOBO Bike’s 2 App HOME page, a shared bike will depict a “FOBO Share” logo at the bottom of bike profile image to distinguish a shared bike from your own bike.



## 5.4 Disable, Release, Replace and Rotate Sensor

You may want to disable a sensor in the App due to physically missing sensor or damaged sensor. Disabling and releasing the missing or damaged sensor in the App will stop monitoring the sensor.

### To Disable a Sensor:

- 1) Click on the box corresponding to the tire position you want to disable.
- 2) Click on the “Disable” option.
- 3) Click “Confirm” to proceed with the action.

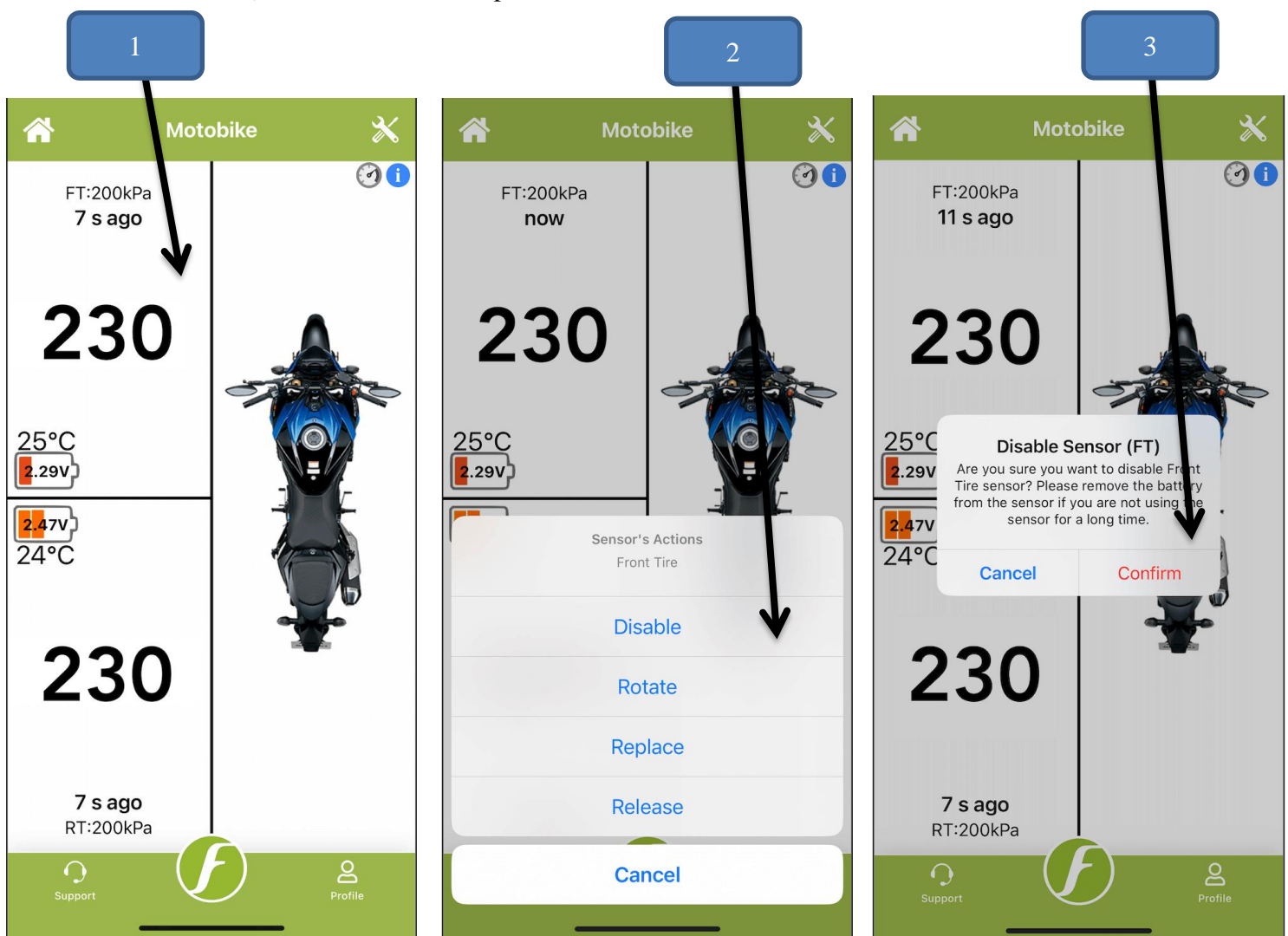

**Note:** Please ensure you are connected to the Internet otherwise app will not perform the action and it will display an error message. You can enable back the same sensor by using the same option.

## To Release a Sensor:

- 1) Click on the box corresponding to the tire position you want to release.
- 2) Click on the “Release” option
- 3) Click “Confirm” to proceed with the action.

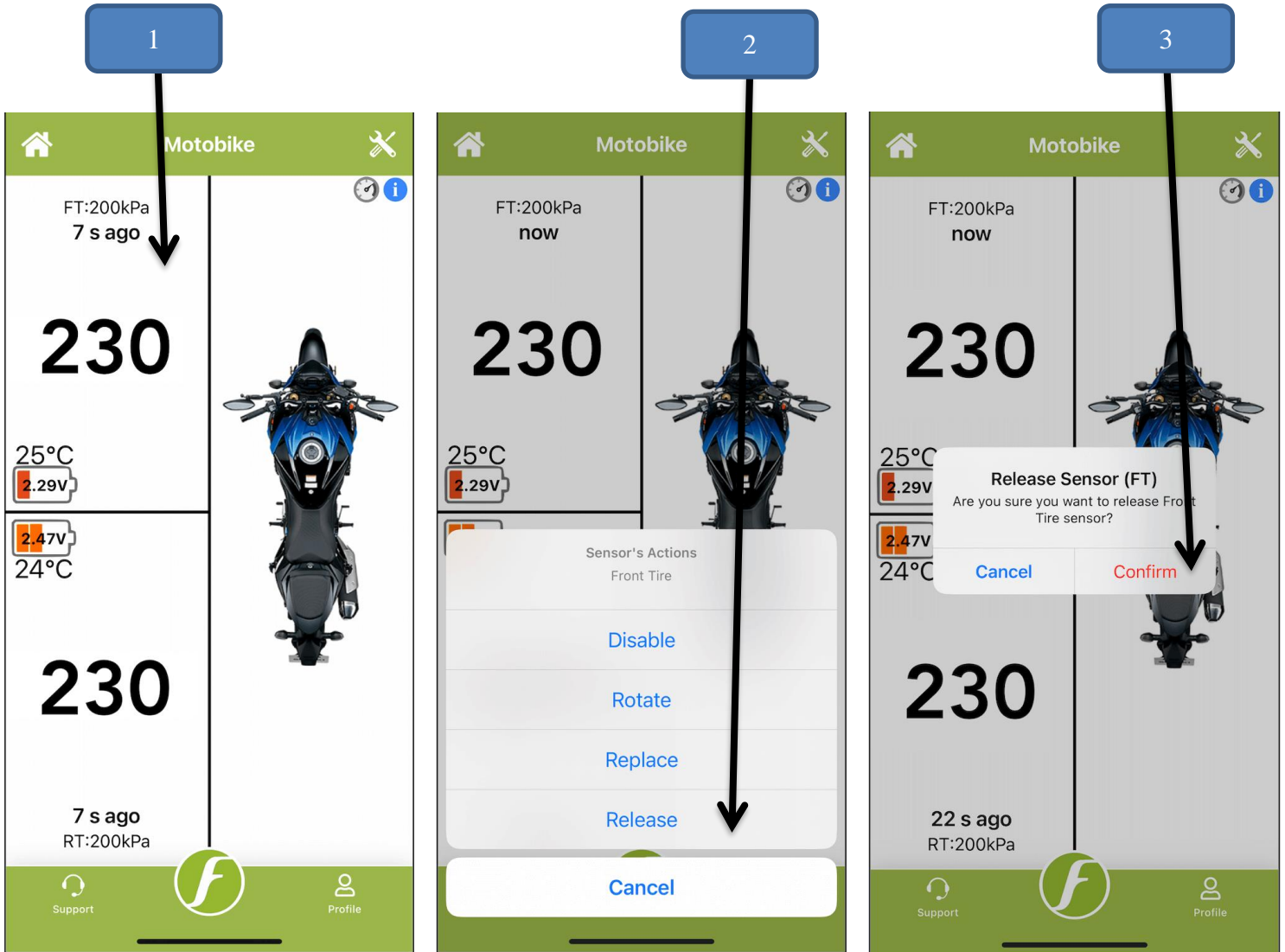

**Note:** Please ensure you are connected to the Internet otherwise app will not perform the action and it will display the error message.

## To Replace a New Sensor:

- 1) Click on the box corresponding to the tire position you want to replace.
- 2) Click on the “Replace” option.
- 3) Click “Confirm” to proceed with the action.

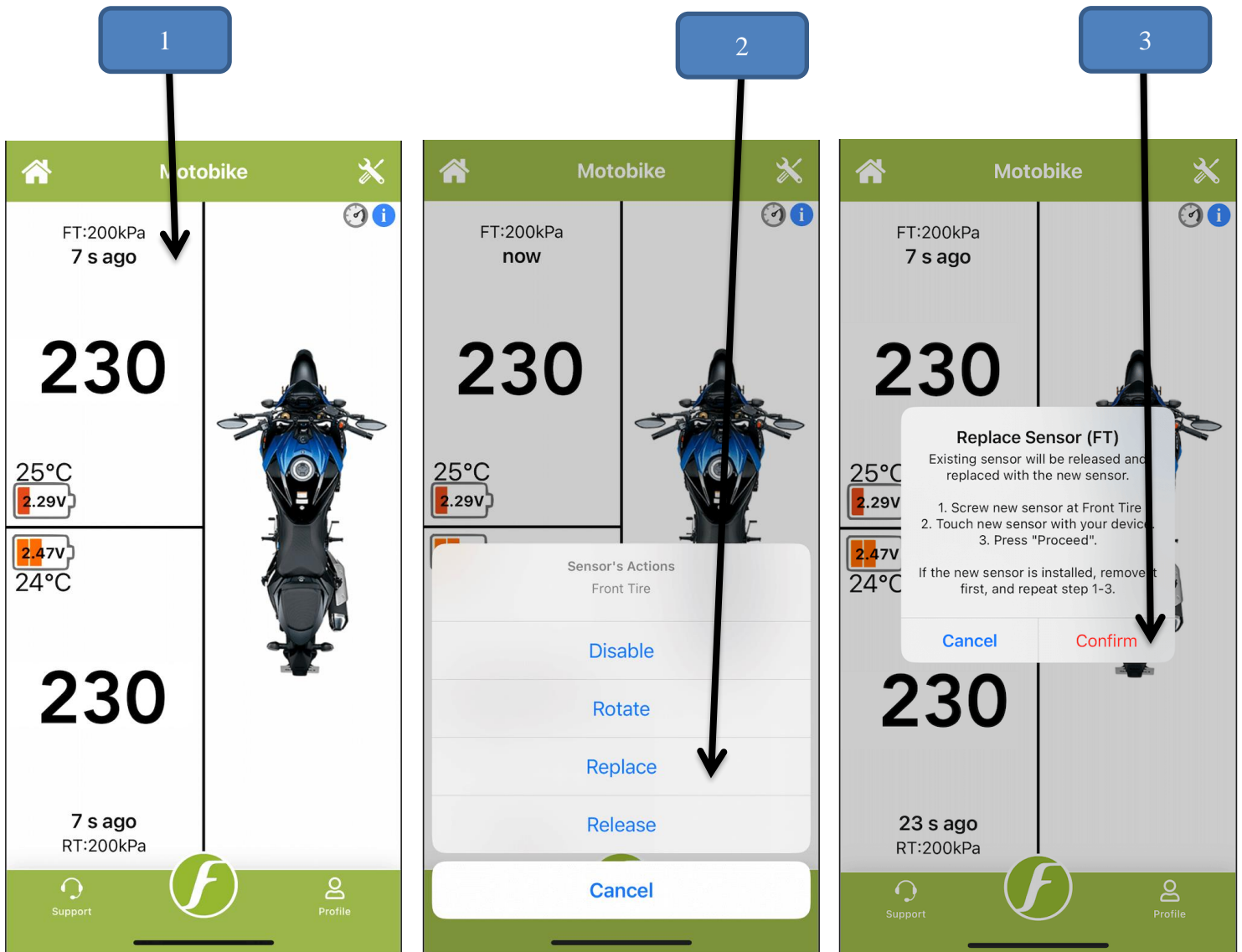

**Note:** Please ensure you are connected to the Internet otherwise app will not perform the action and it will display the error message.

## To Rotate a Sensor:

- 1) Click on the box corresponding to the tire position you want to rotate.
- 2) Click on the “Rotate” option.
- 3) Choose new position of a sensor from the list (in the below screenshots we are rotating Front Tire sensor with Rear Tire sensor).

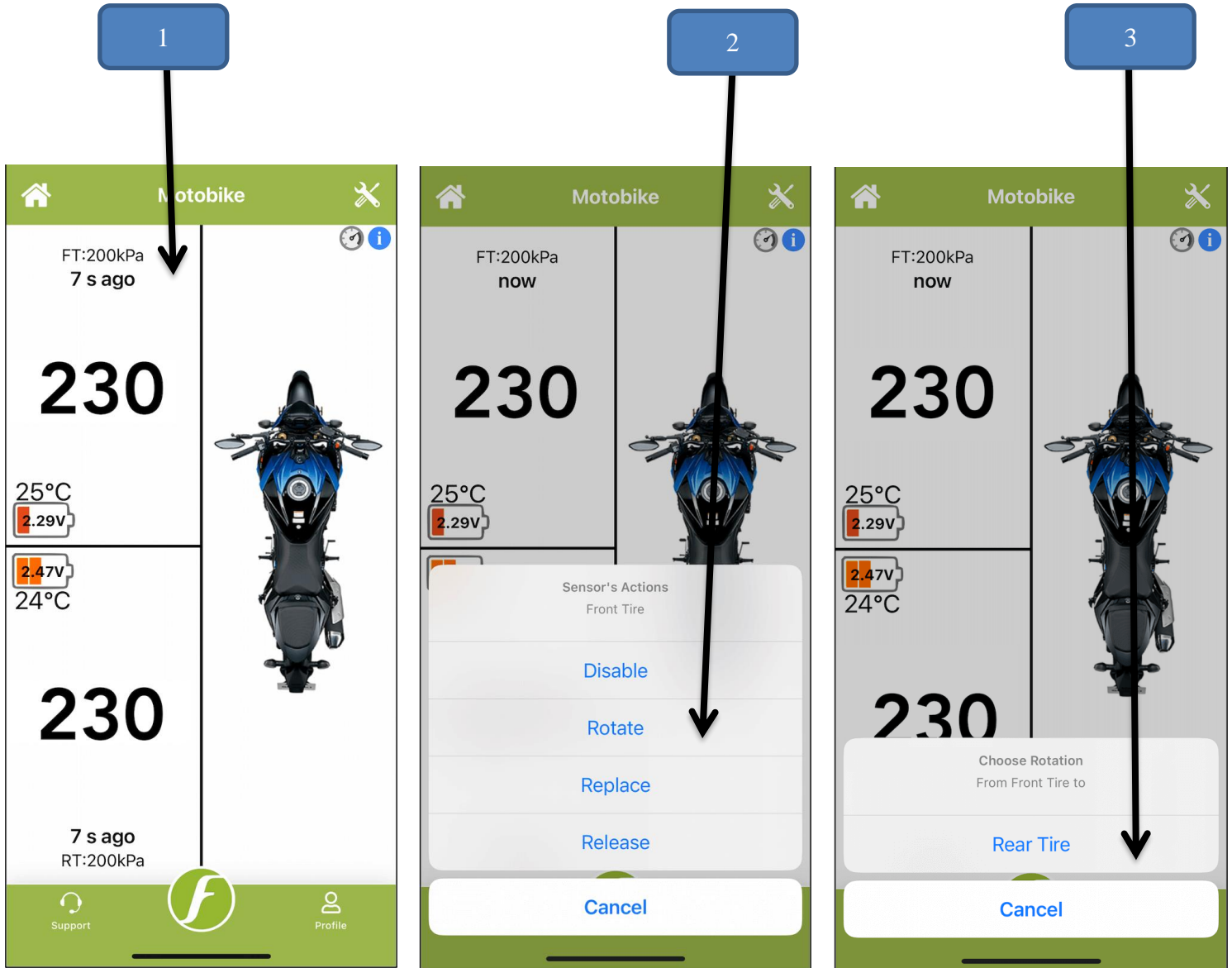

**Note:** Please ensure you are connected to the Internet otherwise the app will not perform the action and it will display the error message.

## 5.5 Gauge Pressure

For users who wish to retain “Gauge Pressure Reading”, the FOBO Bike 2 App has a Gauge Pressure feature, adjusted to local altitude using cell towers or individual phone barometer if available. This Gauge Pressure button can be accessed from the App.

- 1) Click on the “Profile” button.
- 2) Turn on/off gauge pressure by using the toggle button.

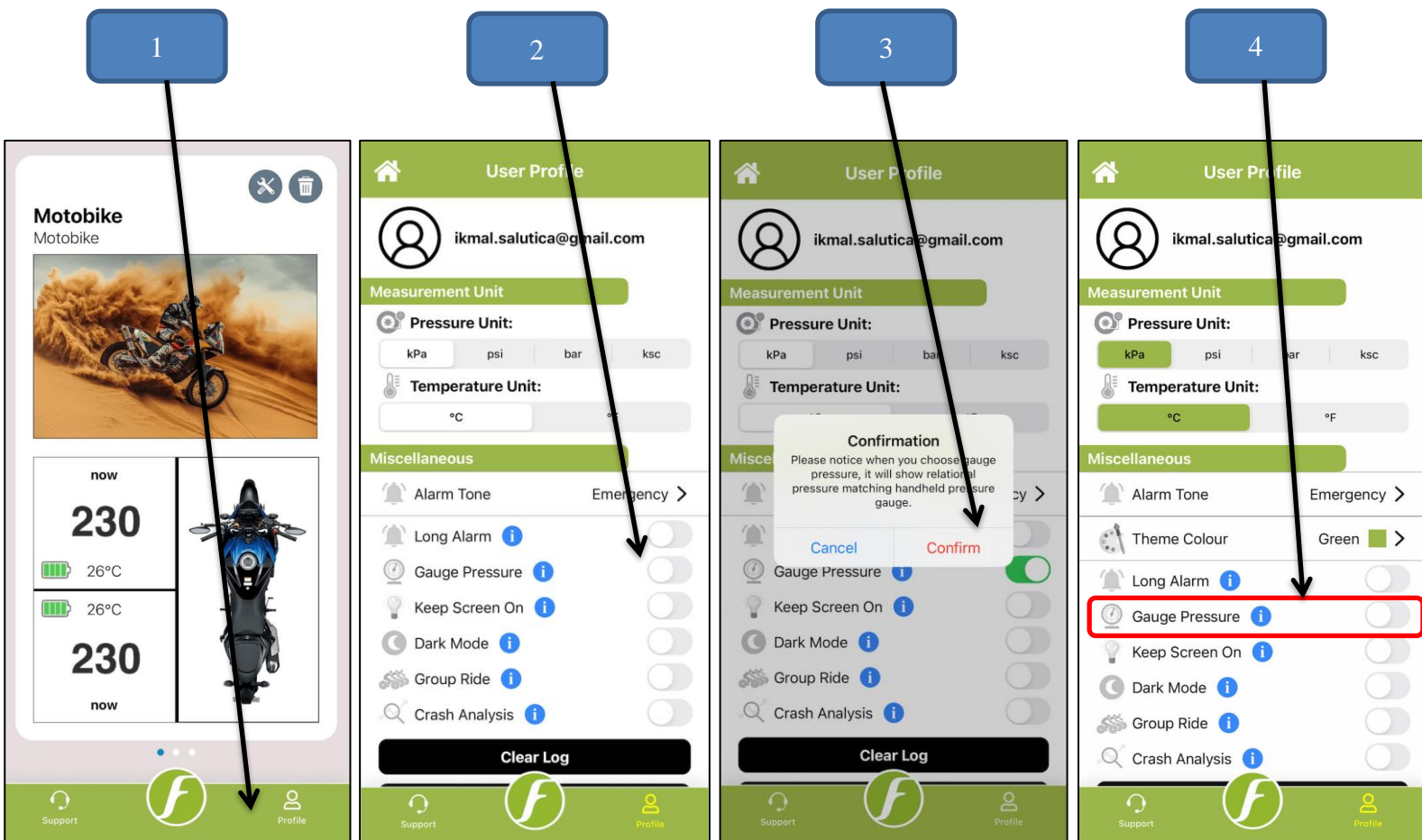

## 5.6 User Profile Page



- |                  |  |
|------------------|--|
| Pressure unit    | - Select pressure unit (kPa, psi, bar, ksc). |
| Temperature unit | - Select temperature unit (°C, °F).          |
| Alarm Tone       | - Select alert ringtone type.                |
| Theme Colour     | - Select the theme colour.                   |
| Long Alarm       | - Make the alarm sound longer.               |
| Gauge Pressure   | - Refer to section 5.5 of this manual.       |

- |                |   |
|----------------|---|
| Keep Screen On | - Keep the screen on when app is running in the foreground. |
| Dark Mode      | - Change the app display to Dark Mode.                      |
| Group Ride     | - Create or join a group and track each other location.     |
| Crash Analysis | - Send anonymous crash report to developer.                 |

You can learn information regarding each feature by pressing the blue colored “i” information icon beside the feature name.

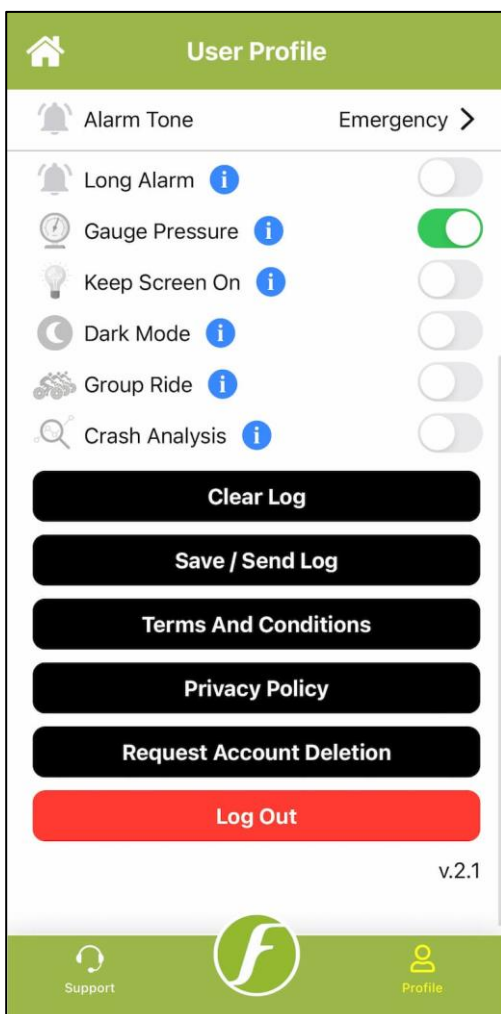

**Clear Log -**

Remove the log files located in the device.

**Save / Send Log -**

Send the log files to an email address.

**Terms And Conditions -**

Read the document governing the contractual relationship between the app and its user.

**Privacy Policy -**

Read a statement or a legal document that states how a company or website collects, handles, and processes data of its users and visitors.

**Request Account Deletion -**

This action removes the account from the FOBO database entirely.

**Log Out -**

Log out from this account.

## 5.7 How to Change the Theme Colour

For users who wish to change the app theme colour other than the default Green colour can do so by pressing the “Theme Colour” option in the User Profile page and select one of the colours that are available in the list.





## 5.8 How to Change Default Bike Image

User can change the default bike image with any other (within specs) image.  
Refer to the below steps:

- 1) Click on the default bike image.
- 2) Choose a source; “Camera” or “Photo Library”.

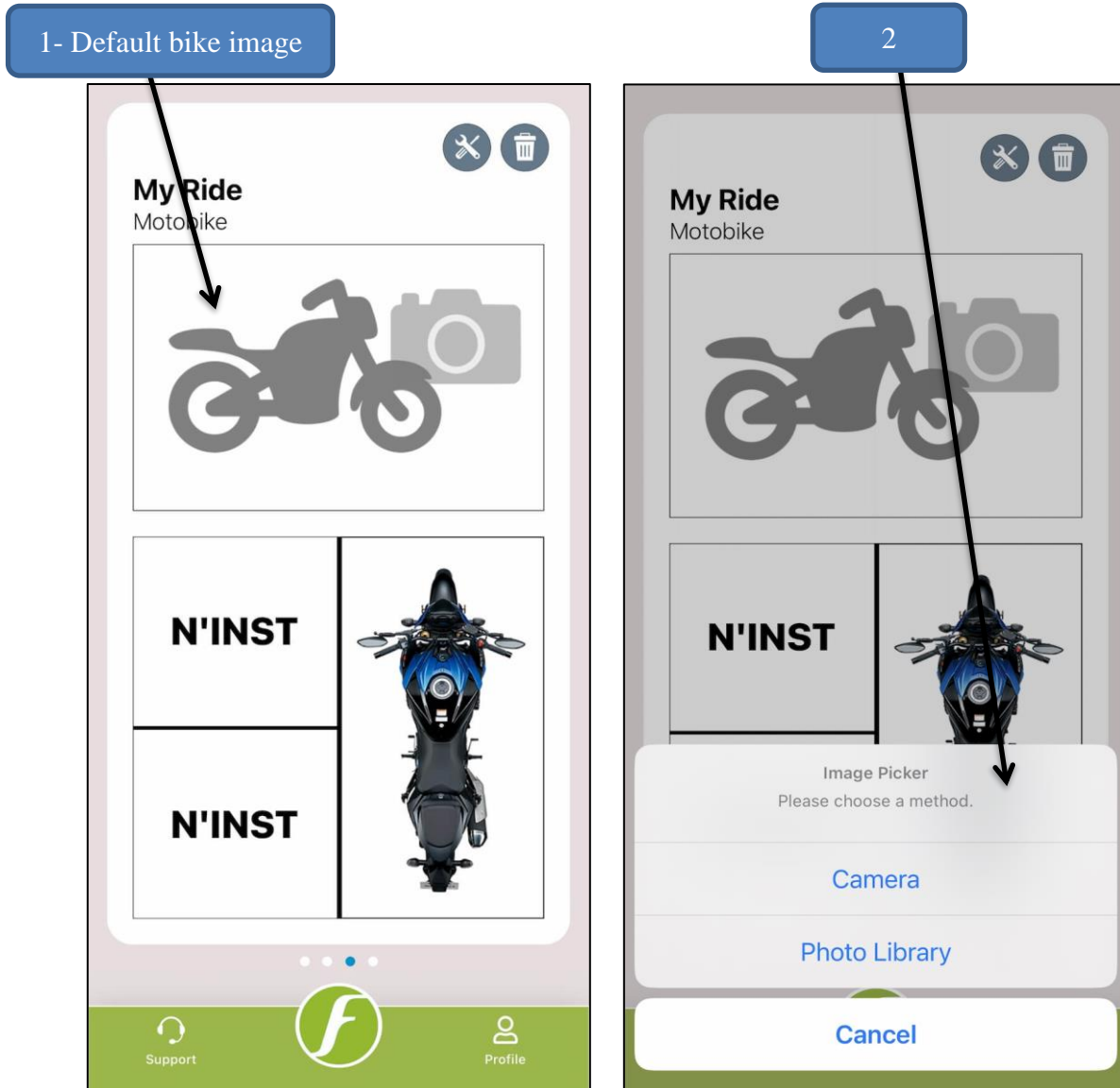

## 5.9 Overlay Services (Android Only)

“Overlay services” feature is an effective approach which helps the users to get the latest pressure, temperature, and battery readings just by a single click on the FOBO overlay icon which is displayed on the mobile home screen without the need of going into the FOBO Bike 2 App. User can use any other App in the foreground with live FOBO readings displayed on the screen. This feature is only available on Android devices.

To turn on the Overlay Service:

1. Open the FOBO Bike 2 App.
2. Click on the settings (Wheel icon at bottom right of screen) on the HOME screen of FOBO Bike 2 App.
3. Turn on the Overlay services under setting.
4. Upon turning on the Overlay services FOBO overlay icon will appear on the screen.
5. Click on the FOBO overlay icon to get the pressure, temperature and battery readings.

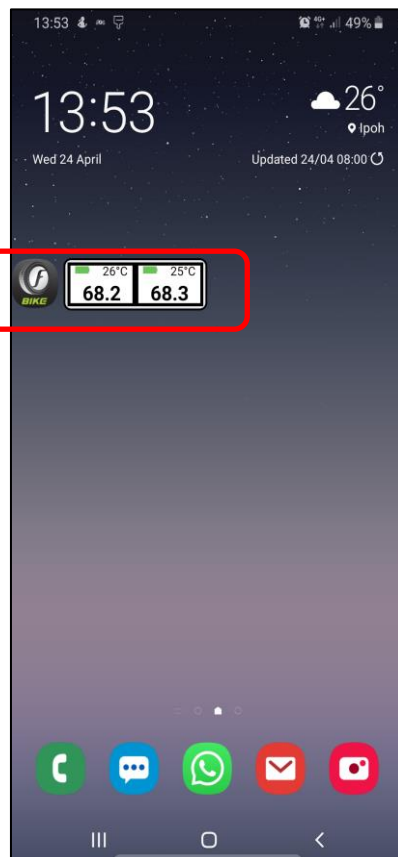
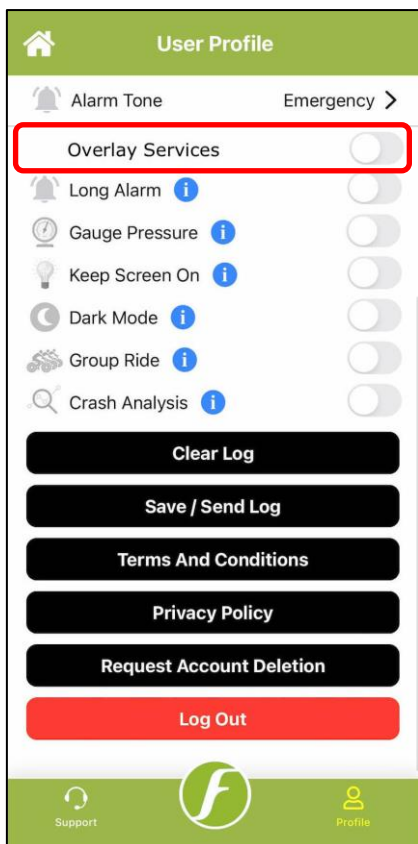

## 5.10 Reference Pressure

Reference pressure is a temperature-compensated tire pressure referenced back to a standard temperature of 20 degree Celsius. This is useful and serves as a guide for the user to decide on the approximate amount of air needed to inflate the tire during hot season or immediately after a long ride.

The reference pressure reading is located below the actual pressure reading in smaller font size. User has an option to show / hide the reference pressure reading for individual profile as shown below.

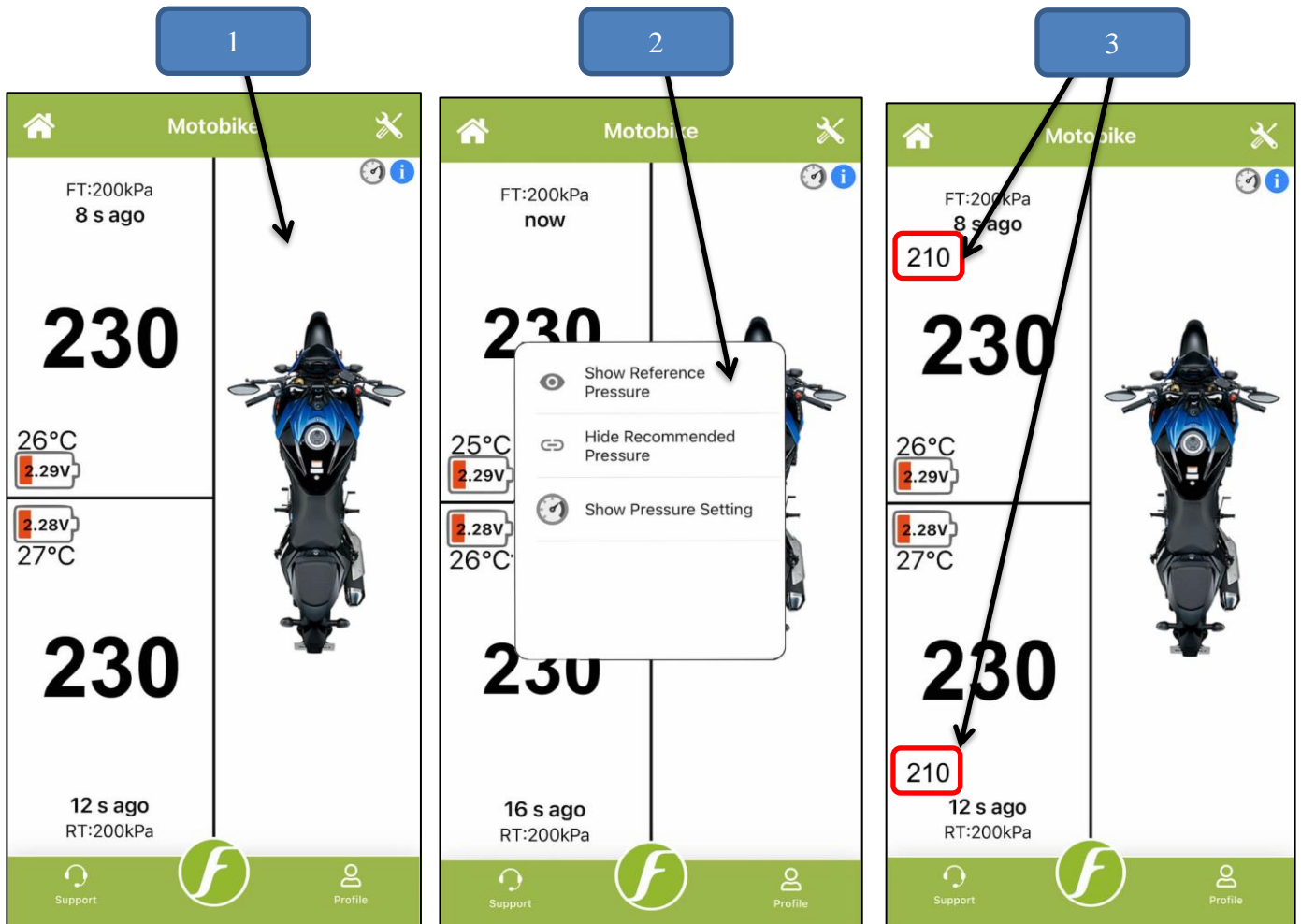

## 5.11 Sensor Graph

The Sensor Graph is a feature that allows you to visualize your tire pressure and temperature in a line graph form.

To view the Sensor Graph, click on the desired sensor position (FT or RT) to open the Sensor Details page, then, scroll all the way down.

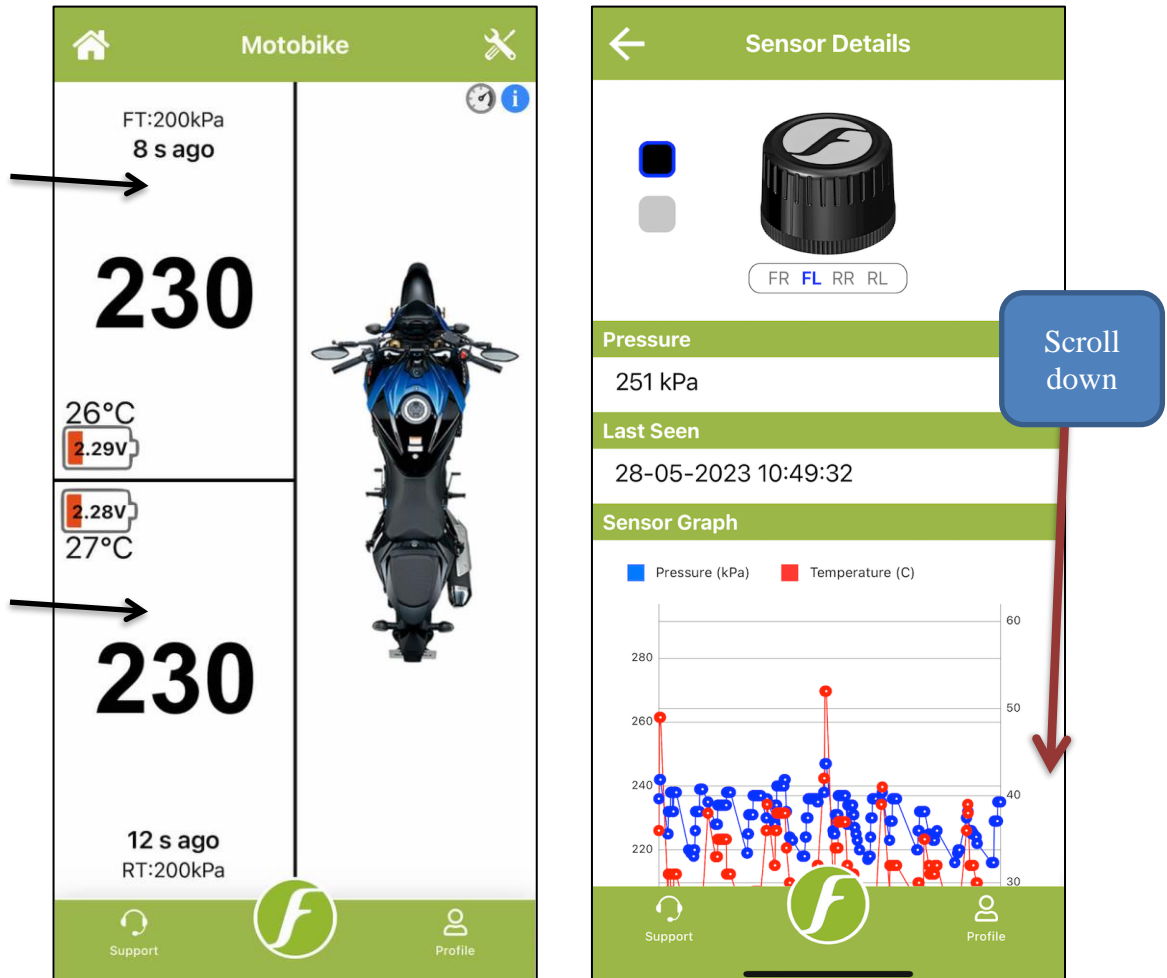

The graph data is originated from your sensor logs. If your sensor logs are empty, or you have recently cleared the logs, the Sensor Graph will not appear and instead you will see a text displaying “No chart data available”.

The pressure line will be displayed in **BLUE** color while the temperature line will be shown in **RED** color. On the left is the pressure labels, on the right is the temperature labels, and at the bottom is the date and time labels.

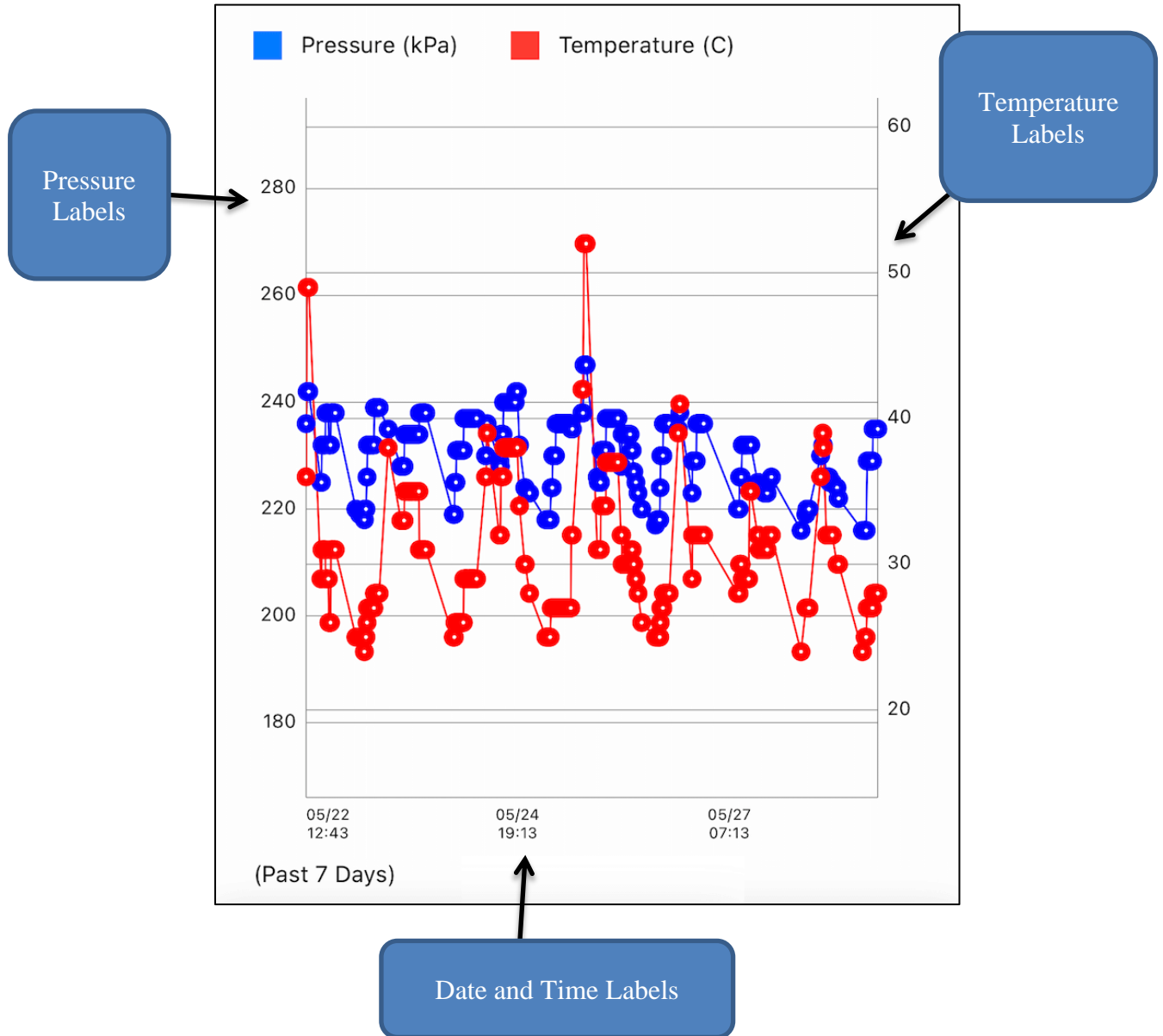

The Sensor Graph will display data from the past 7 days.

1. To zoom in into the graph, “un-pinch” your fingers over the graph.
2. To display the pressure and temperature of a specific graph point, press on any of the blue / red point. An orange vertical line will appear to indicate the data selected is belonging to which date and time.

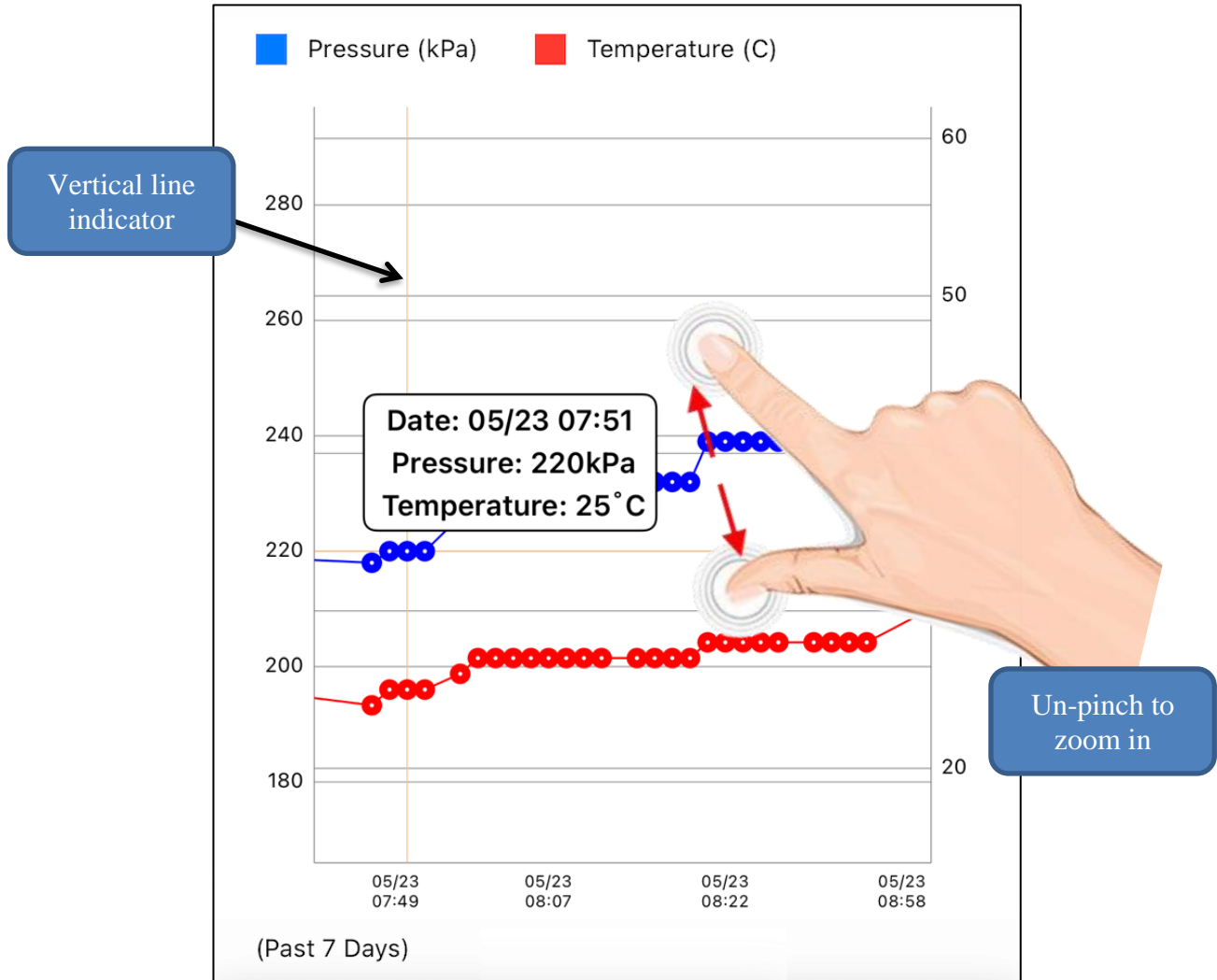

## 5.12 Sensor Firmware Upgrade

FOBO Bike 2 app also allows you to upgrade FOBO Bike 2 sensor firmware. Follow the below steps to upgrade sensor firmware:

1. Click on the desired sensor position (FT or RT) to open the Sensor Details page. On that page, click the “Upgrade” button.

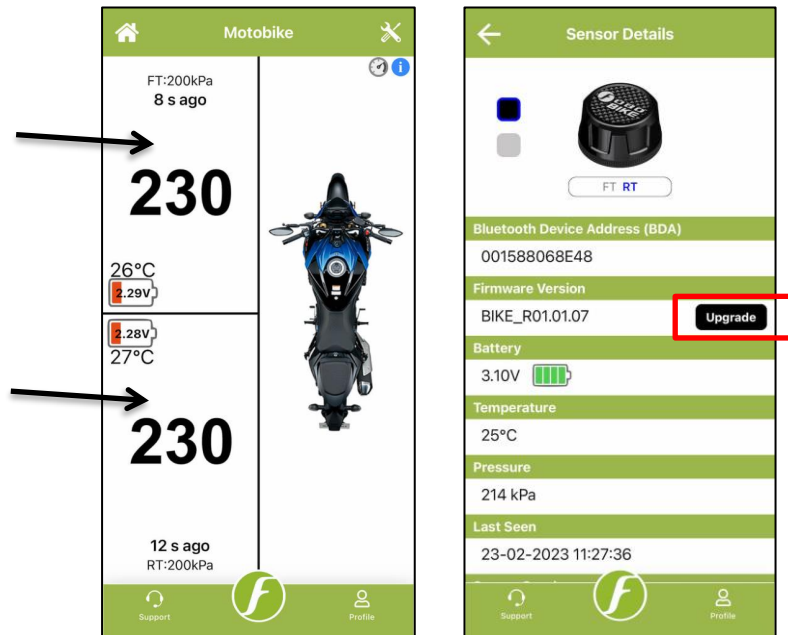

2. Read and follow the instructions carefully on next page.



3. Click the “Start” button to initiate the firmware upgrade.



**Note:** If there is no upgrade available then App will display a message “The firmware version is the latest version”.



## 5.13 Delete a Profile

To delete a profile, press on the “Bin” icon as shown in the picture below.

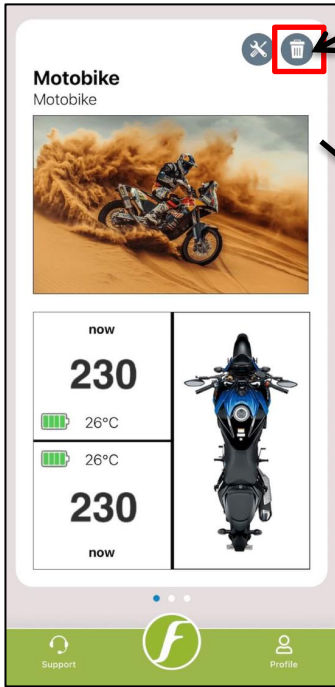

If the profile contains sensor, a warning will appear telling user to release all sensor under the profile first before deletion.

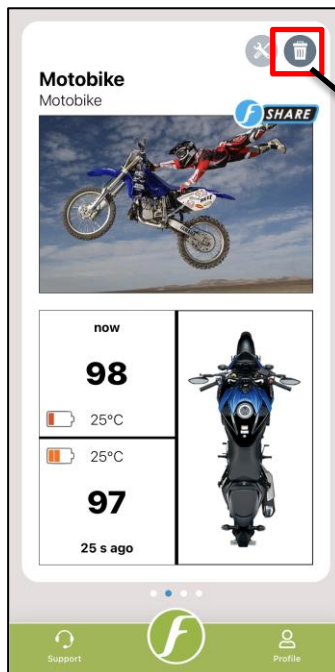
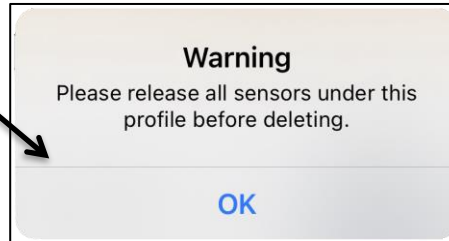

If the profile is a “Share” profile, the profile will be deleted after pressing the “Confirm” button.

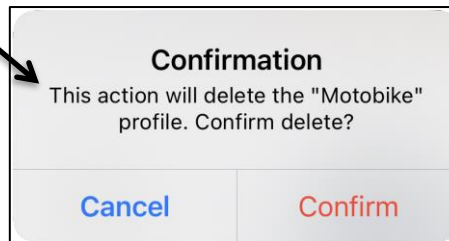

**Note:** Please ensure you are connected to the Internet otherwise the app will not perform the action and it will display the error message.

## 5.14 “Group Ride” Feature

Group Ride feature will let riders form a group ride with a planned destination. During the group ride, riders can know the tire pressure status and the relative locations of one another in the Map View. If you find that your riding peer is missing and see a tire pressure alert insignia by his bike profile, you know that he may be stranded at the location on the Map View and may use your help. This is useful when cellular phone signal is not available to call for help.

Refer to the below steps explaining how to create group under Group ride, add group members in a group & other feature details:

### How to create Group?

Prior to using this feature please ensure you have downloaded the latest FOBO Bike 2 App version from Google play store or Apple App store on your compatible smart device.

Step 1 – Click on “Profile” icon at the bottom of FOBO Bike 2 App home page screen.

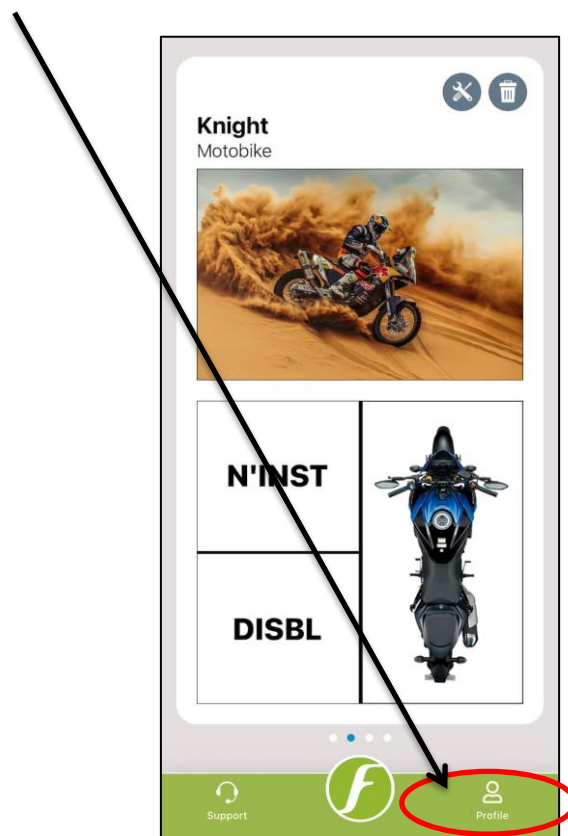

Step 2 – Turn on “Group Ride” feature by using the toggle button. And then when you press the “Home” button you will notice a new icon pop-up at the near bottom right corner.

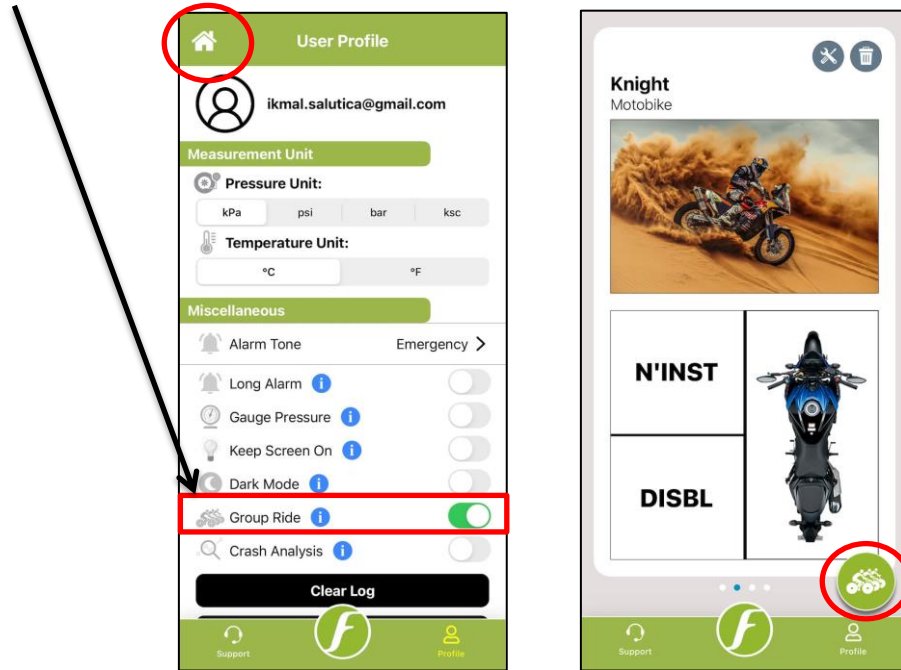

Step 3 – Click on the icon and you will be presented with the page below. Click on the middle button to create a new group.

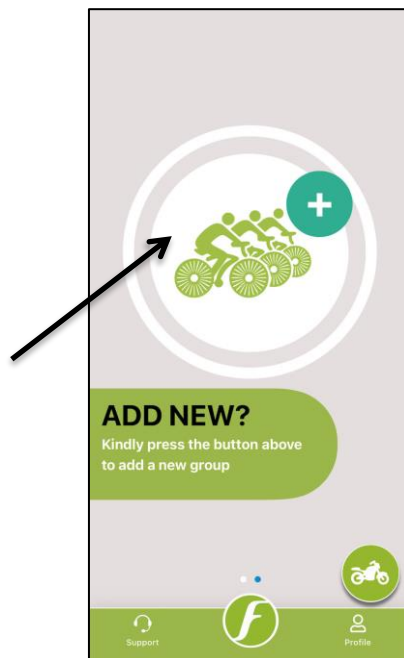

Step 4 – Select bike from the available bike list. **Group leader must have one bike (with sensors installed) profile in order to create a group.**

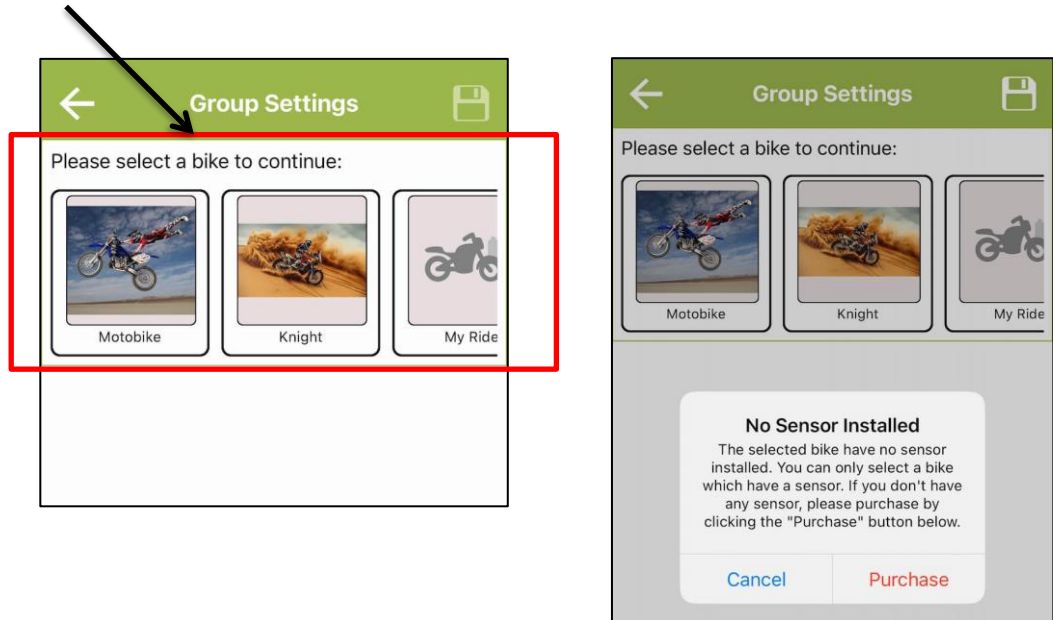

Step 6 – Key in Group Photo, Group Name, Member Nick Name, select Origin and Destination coordinates. Press the “Save” button once done.

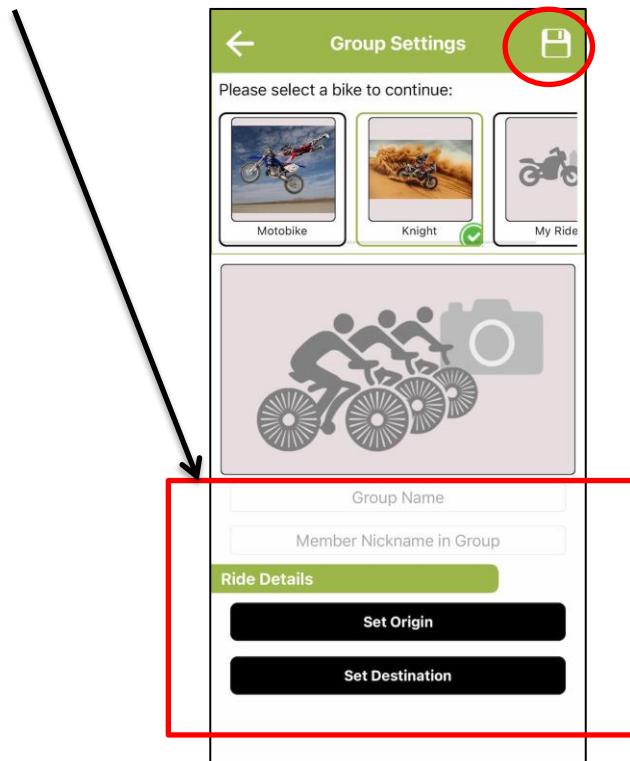

Your Group is created as seen in an example shown below. For a newly created group, it will only have one member, which is the leader himself/herself.

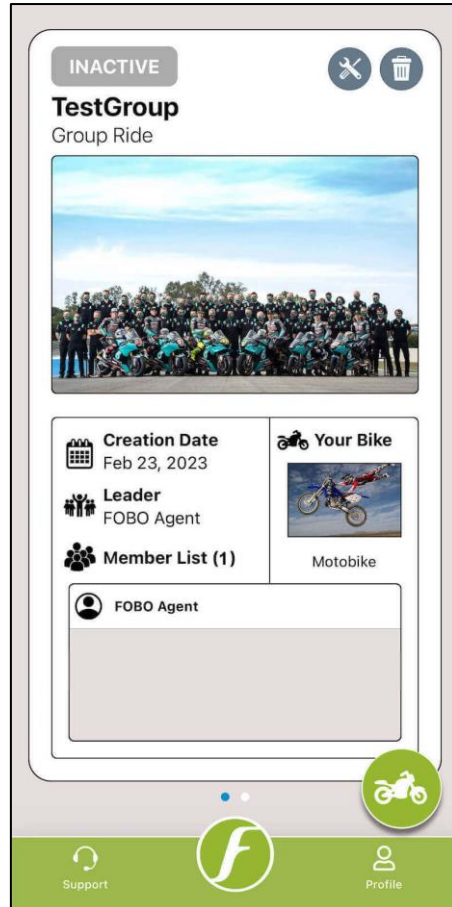

## How to invite Group Members?

Step 1 – Press the “Group Settings” button at the top right corner of the Group Home page.

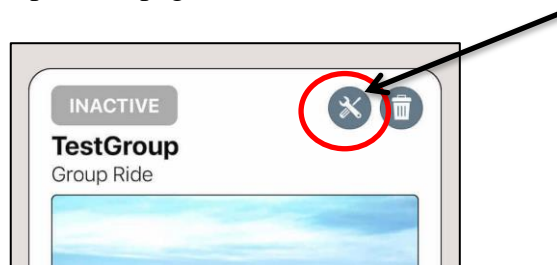

Step 2 – Click on the “Invite Member” at the Group Setting page.

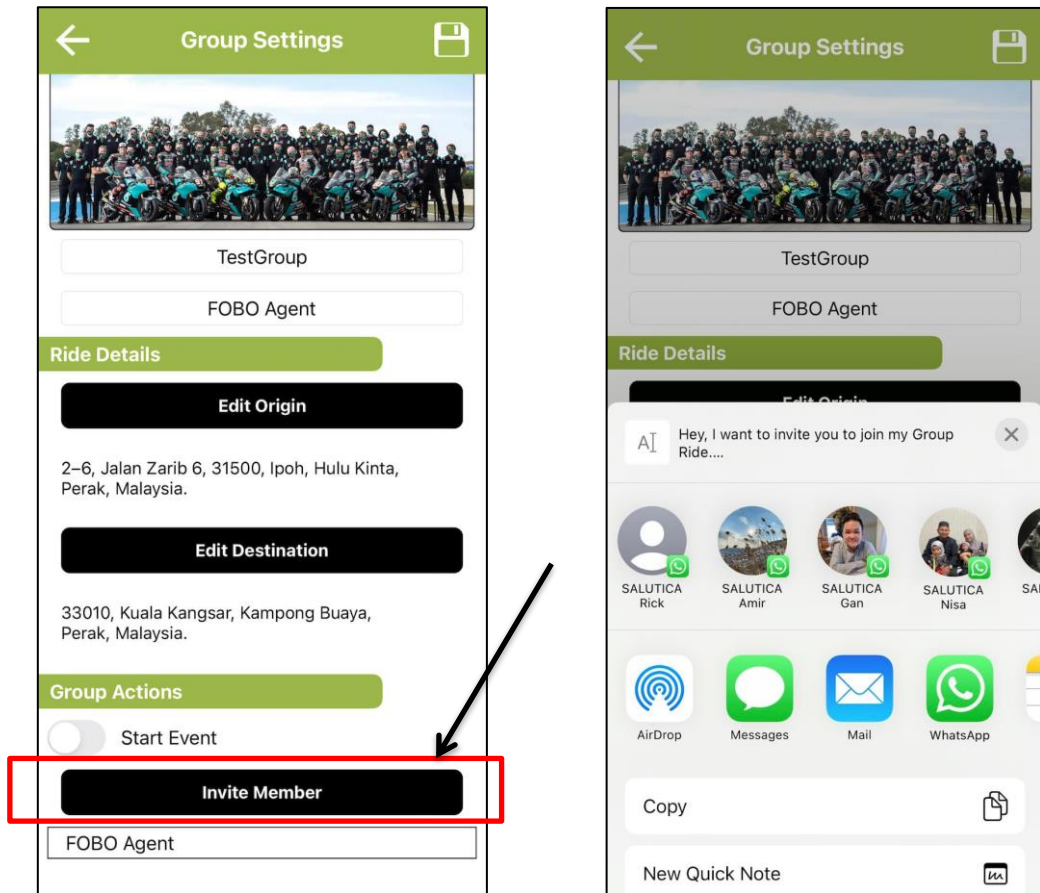

Step 3 – Send the invitation link by choosing from any of the available options such as WhatsApp, Email and Messages.

Upon receiving the link, group member needs to click on the link. Upon clicking the link, it will redirect member to the FOBO Bike 2 app and the shared group will appear under the group selection list.

Members cannot join the Group until group leader start the event. In order to start an event group leader need to follow the below:

- Step 1: Click on the desired group from the group selection list.
- Step 2: Click on “Start” to start the event.

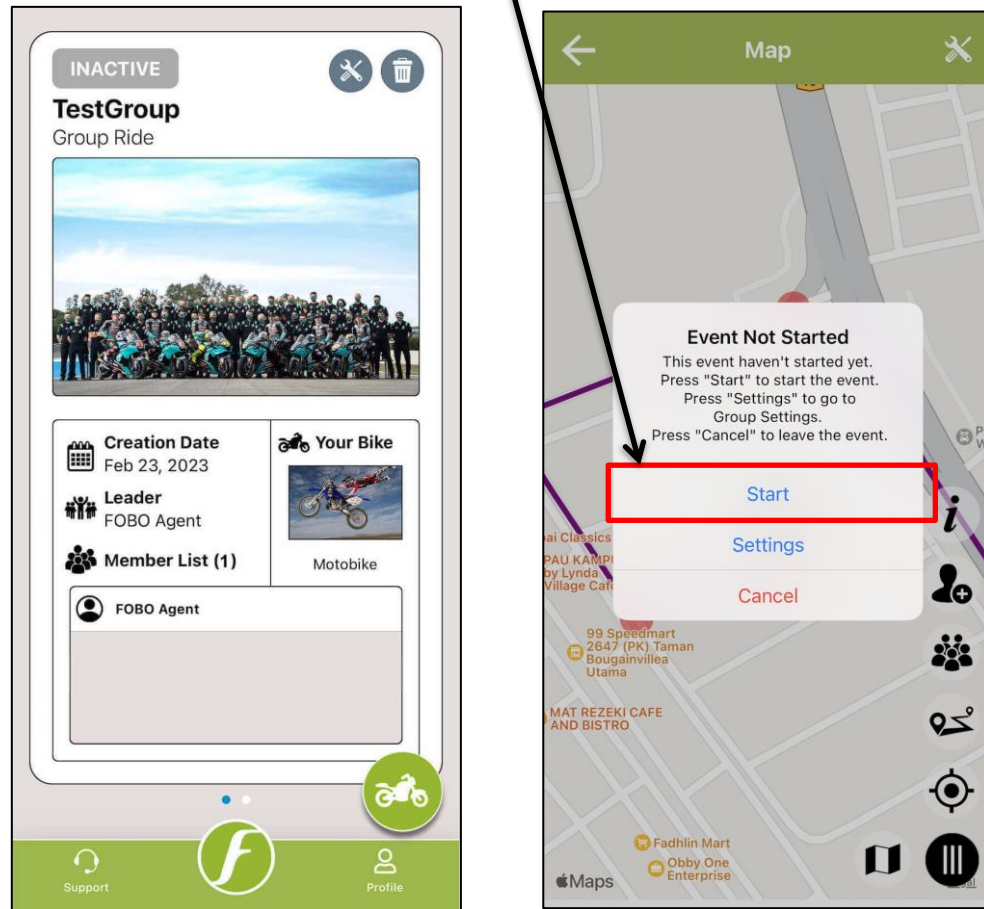

Other group members can only join the event once the event has been started by the Group leader.

# Group Ride Map View

The screenshot shows a mobile application interface for a group ride. The main map displays a purple route through Ipoh, with various icons for group members and information. Callouts provide instructions on how to interact with these elements.

**Information Panel (Left):**

- Information:** Map Legends
  - Group Leader (Blue location pin)
  - You (Green location pin)
  - Other Member (Blue location pin)
  - Not Updating (More Than 5 Minutes) (Grey location pin)
  - Pressure Alert (Red location pin)
- Member List:** Active Status (1/1) Refresh
  - FOBO Agent:** ikmal.salutica@gmail.com (Join in: 2 month(s) ago)

**Map Callouts:**

- Click on individual tag to get further details (Pressure, Temperature readings and member name)
- Click here to check tags information
- Click here to invite a new member
- Click here to check member list
- Click here to view the route overview
- Click here to zoom to your current location
- Click here to change the map type
- Click here to hide all feature buttons

**FOBO Agent Detail View (Top Right):**

FOBO Agent	
25°C	
230	
25°C	
230	



## How to Stop an Event?

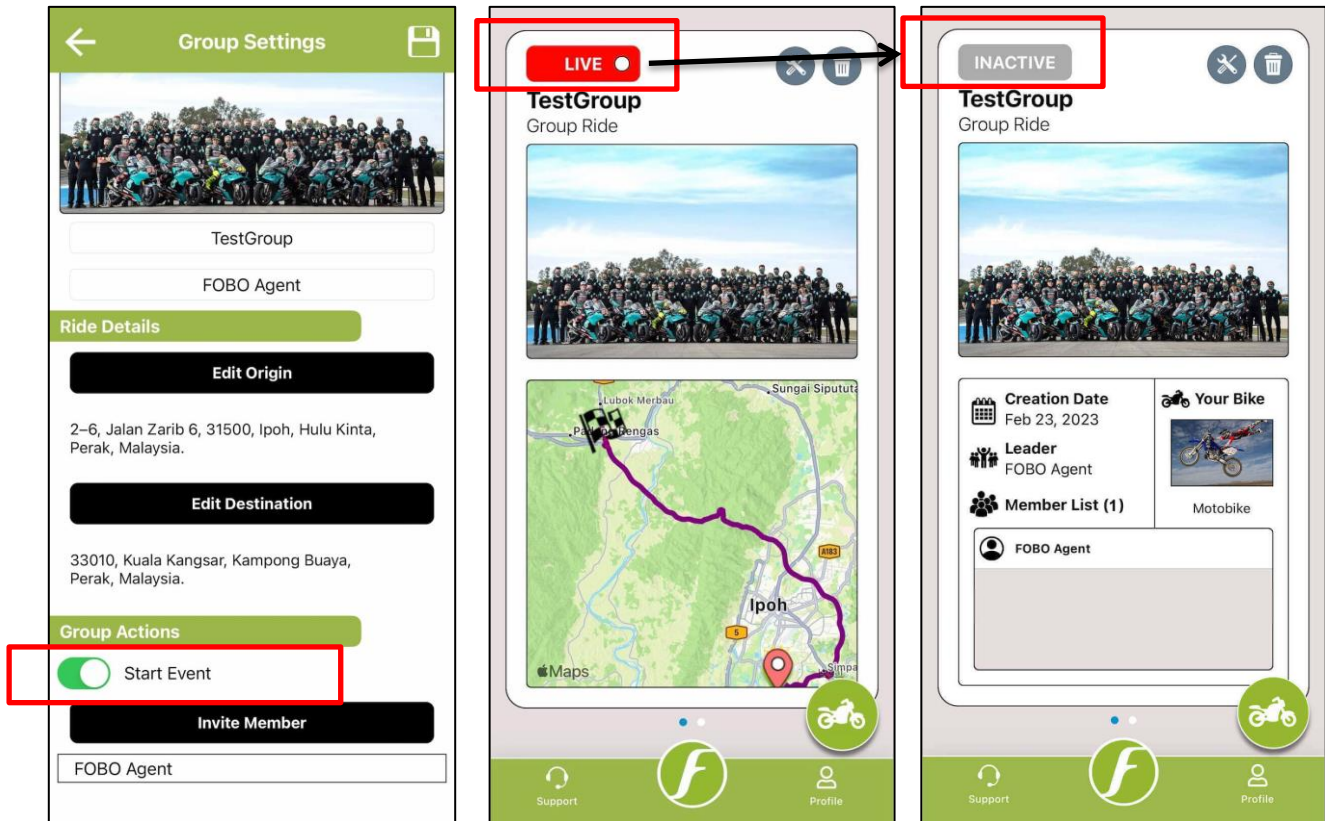

Group leader can Start and Stop an event under Group settings page, he/she need to click on the box next to “Start Event” to start an event and click again to stop the event. Group leader must hit “Save” icon at top right corner after making any changes under the settings.

The “LIVE” icon will change to “INACTIVE”, and the map will disappear once the event has stopped.

**Note:** Group members can only join one event at any given time.

## 6 FOBO Bike 2 Alert Messages

You will get the following alert messages on your smartphone during the operation of FOBO Bike 2 under different breached conditions. When you receive an alert, please find a safe location to stop your bike and check the alert messages on the smartphone.

### 6.1 Pressure Below Preset Limit

You will receive an alert when the tire pressure drops below 8 % ( first level alert – L1) or 15% (second level alert – L2) or 25 % (third level alert – L3) of the Recommended pressure that you have set or at and below 30kPa (0.3bar/4.35psi). For fuel economy and optimum tire performance, it is recommended to maintain this 8% range so that you can keep your tires inflated optimally. If you find the reminder is too frequent, you may want to check your tire for any leakage. Note that drastic temperature drop may also cause tire pressure drop. Please check your tire pressure and re-inflate during change of seasons.

### 6.2 Pressure Above Preset Limit

You will receive an alert when the tire pressure increases beyond 25 % ( first level alert – L1) or 35% (second level alert – L2) or 45 % ( third level alert – L3) of the Recommended pressure that you have set or at and below 800kPa (8bar/116psi). For optimum tire performance and grip, you should not overinflate your bike tires. Note that the tire pressure will naturally increase as the bike tires heat up due to friction while driving. However, you should check your tire in the event of an abnormal rise in the tire pressure.

**NOTE: IT IS DANGEROUS TO RIDE WITH LOW TIRE PRESSURE AND IT MAY LEAD TO A BLOW-OUT. PLEASE STOP THE BIKE AND HAVE THE TIRE CHECKED WHEN YOU RECEIVE THIS ALERT.**

# L1, L2 & L3 Alert Notification for pressure below pre-set limits

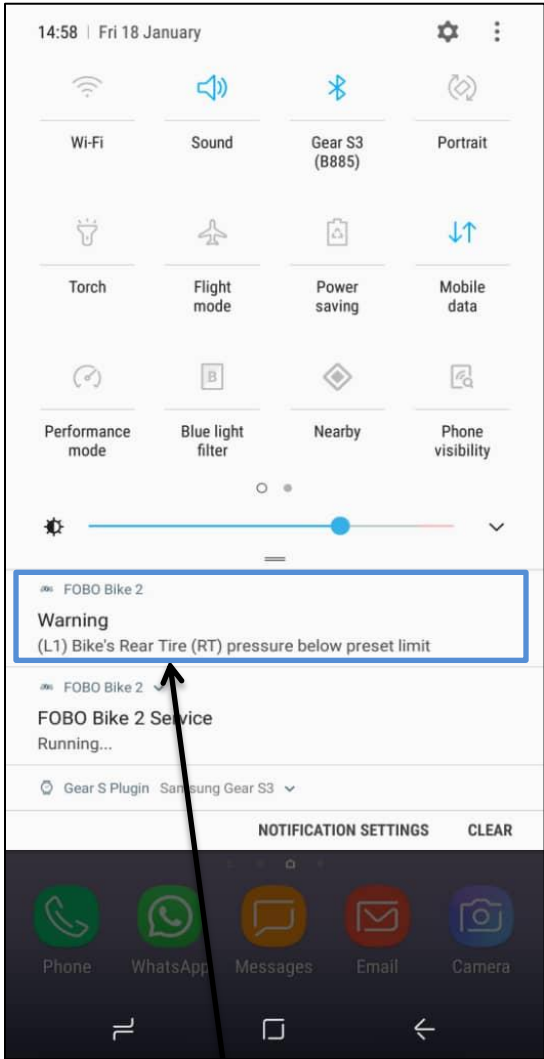

L1 Alert

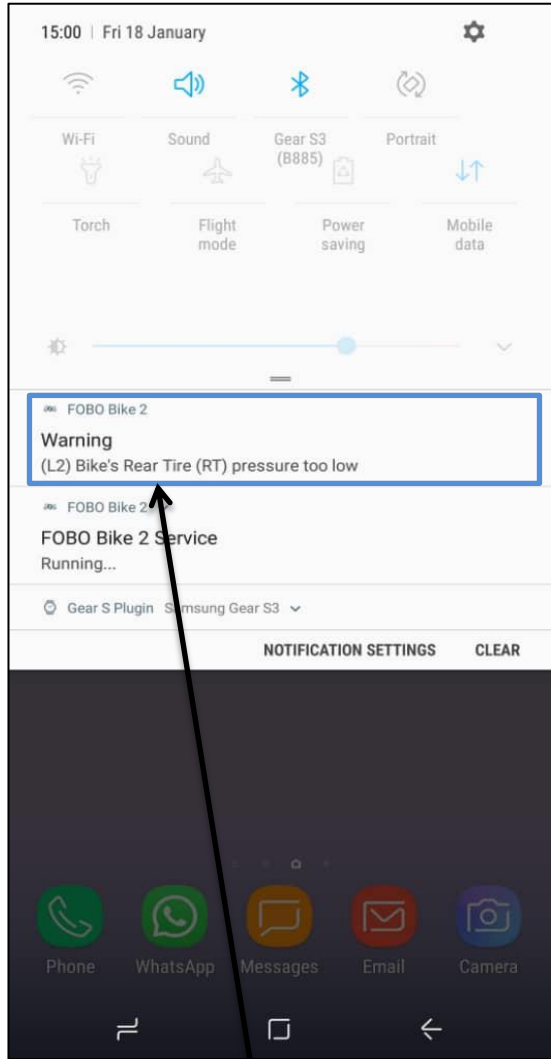

L2 Alert

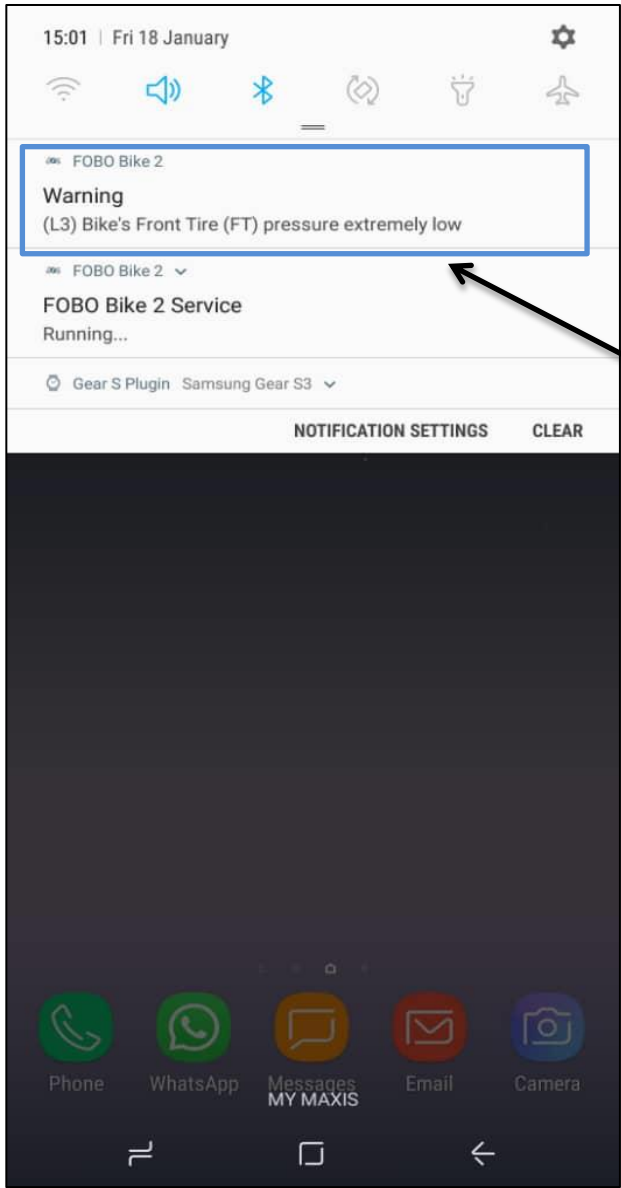

L3 Alert

## 7 FOBO Bike 2 sensor (TM1802) Specifications

- **Bluetooth:** v5.0
- **Transmit Conducted Power:** +5.0dBm (sensor)
- **Receiver Sensitivity:** Conducted Sensitivity -97dBm @ 0.1%BER
- **Antenna Return Loss:** Typical -9dB
- **Operating Frequency:** 2.402~2.480 GHz
- **Battery Type:** CR1632 (sensor). Operating life up to 1 year. (NOTE: The battery operating life varies according to usage and climate temperature)
- **Operating Temperature:** -40°C to +85°C (sensor), -20°C to +60°C (sensor with common CR1632 batteries)
- **Weight:** 7.6g (sensor –with battery)
- **Sensor Dimension H x D:** 13.8mm x 20.2mm
- **Maximum Pressure:** 800kPa (116psi)
- **ESD:** 8kV air discharge & 4kV direct contact discharge according to CE standard
- **Operating Humidity:** up to 90% non-condensing at 40oC
- **Dust and Water Proof:** IEC60529 compliant to IP57(sensor)
- **Sensor structural threshold:** 100N ball pressure intensity test
- **Mechanical & Environmental Reliability Testing Standards:** IEC 60068-2-2, IEC 60068-2-1, ISO 21750, IEC 60068-2-29, IEC 60068-2-5, IEC 60068-2-32, ISO 15184, ISO 2409, SAE J2657, SAEJ113/13

## 8 Warning

- Take note that FOBO Bike 2 is not meant to function as anti-accident or anti-injury device. FOBO Bike 2 is not a substitute for safe tire maintenance practices. Please take full responsibility of your own safety while riding. And continue to send your bike for regular tire check and maintenance.
- You shall not use the FOBO Bike 2 in any unlawful way that violates any laws.
- Avoid exposing the FOBO Bike 2 sensors to solvent, fire or extreme temperatures.
- FOBO Bike 2 may fail to function properly if the battery is below optimum level. Replace the battery immediately to continue enjoying full features of FOBO Bike.

## CAUTION

**THERE MAY BE A RISK OF EXPLOSION IF BATTERY IS REPLACED BY AN INCORRECT TYPE. DISPOSE ALL USED BATTERIES PROPERLY.**

# 9 Regulatory Information

## Federal Communication Commission Interference Statement

This device complies with Part 15 of the FCC Rules. Operation is subject to the following two conditions: (1) This device may not cause harmful interference, and (2) This device must accept any interference received, including interference that may cause undesired operation.

This equipment has been tested and found to comply with the limits for a Class B digital device, pursuant to Part 15 of the FCC Rules. These limits are designed to provide reasonable protection against harmful interference in a residential installation. This equipment generates uses and can radiate radio frequency energy and, if not installed and used in accordance with the instructions, may cause harmful interference to radio communications. However, there is no guarantee that interference will not occur in a particular installation. If this equipment does cause harmful interference to radio or television reception, which can be determined by turning the equipment off and on, the user is encouraged to try to correct the interference by one of the following measures:

- Reorient or relocate the receiving antenna.
- Increase the separation between the equipment and receiver.
- Connect the equipment into an outlet on a circuit different from that To which the receiver is connected.
- Consult the dealer or an experienced radio/TV technician for help.

FCC Caution: Any changes or modifications not expressly approved by the party responsible for compliance could void the user's authority to operate this equipment.

This transmitter must not be co-located or operating in conjunction with any other antenna or transmitter.

**FOR PORTABLE DEVICE USAGE (<20m from body/SAR needed e.g. BT dongle, smartphone)**

**Radiation Exposure Statement:**

The product comply with the FCC portable RF exposure limit set forth for an uncontrolled environment and are safe for intended operation as described in this manual. The further RF exposure reduction can be achieved if the product can be kept as far as possible from the user body or set the device to lower output power if such function is available.

**FOR MOBILE DEVICE USAGE (>20cm/low power eg. AP routers)**

**Radiation Exposure Statement:**

This equipment complies with FCC radiation exposure limits set forth for an uncontrolled environment. This equipment should be installed and operated with minimum distance 20cm between the radiator & your body.

**Industry Canada statement:**

This device complies with ISED's licence-exempt RSSs. Operation is subject to the following two conditions: (1) This device may not cause harmful interference, and (2) this device must accept any interference received, including interference that may cause undesired operation.

Le présent appareil est conforme aux CNR d' ISED applicables aux appareils radio exempts de licence. L'exploitation est autorisée aux deux conditions suivantes : (1) le dispositif ne doit pas produire de brouillage préjudiciable, et (2) ce dispositif doit accepter tout brouillage reçu, y compris un brouillage susceptible de provoquer un fonctionnement indésirable.

**FOR PORTABLE DEVICE USAGE (<20m from body/SAR needed)**

**Radiation Exposure Statement:**

The product comply with the Canada portable RF exposure limit set forth for an uncontrolled environment and are safe for intended operation as described in this manual. The further RF exposure reduction can be achieved if the product can be kept as far as possible from the user body or set the device to lower output power if such function is available.

### **Déclaration d'exposition aux radiations:**

Le produit est conforme aux limites d'exposition pour les appareils portables RF pour les Etats-Unis et le Canada établies pour un environnement non contrôlé.

Le produit est sûr pour un fonctionnement tel que décrit dans ce manuel. La réduction aux expositions RF peut être augmentée si l'appareil peut être conservé aussi loin que possible du corps de l'utilisateur ou que le dispositif est réglé sur la puissance de sortie la plus faible si une telle fonction est disponible.

### **FOR MOBILE DEVICE USAGE (>20cm/low power)**

#### **Radiation Exposure Statement:**

This equipment complies with ISED radiation exposure limits set forth for an uncontrolled environment. This equipment should be installed and operated with greater than 20cm between the radiator & your body.

### **Déclaration d'exposition aux radiations:**

Cet équipement est conforme aux limites d'exposition aux rayonnements ISED établies pour un environnement non contrôlé. Cet équipement doit être installé et utilisé à plus de 20 cm entre le radiateur et votre corps.

## **European Union Regulatory Conformance**

This equipment is CE marked according to the provisions of the R&TTE Directive (99/5/EC) and is in compliance with the essential requirements and other relevant provisions of the Directive 1999/5/EC. This equipment meets the following conformance standards:

EN 300 328, EN62479, EN 301 489-1&17, EN 60950-1

### **EU Declaration of Conformity**

Hereby, Salutica Allied Solutions Sdn. Bhd. declares that this Bluetooth device is in compliance with the essential requirements and other relevant provision of Directive 1999/5/EC.

**Caution:** Changes or modifications to this **FOBO** device not expressly Approved by the party responsible for compliance could void the user's authority to operate it.

### **Bluetooth Wireless Compatibility:**



This **FOBO** device supports the following Bluetooth wireless protocols and profiles:

- Bluetooth core technology v4.0
- Battery Profile (BAS)
- Proximity (PXP)
- Device Information Service (DIS)

**Bluetooth Wireless Interoperability:**

This **FOBO** device is designed to be interoperating with all Bluetooth wireless products that support compatible profiles and roles including:

- Bluetooth core technology v4.0
- Bluetooth master and slave roles

**低功率電波輻射性電機管理辦法**

- 第十二條 經型式認證合格之低功率射頻電機，非經許可，公司、商號或使用者均不得擅自變更頻率、加大功率或變更原設計之特性及功能。
- 第十四條 低功率射頻電機之使用不得影響飛航安全及干擾合法通信；經發現有干擾現象時，應立即停用，並改善至無干擾時方得繼續使用。前項合法通信，指依電信法規定作業之無線電通信。低功率射頻電機須忍受合法通信或工業、科學及醫療用電波輻射性電機設備之干擾。

## 12. Intellectual Properties

- FOBO™ is a trademark of Salutica Allied Solutions Sdn Bhd. All rights reserved.
- FOBO™ Bike 2 incorporates a few patent pending technologies solely owned by Salutica Allied Solutions Sdn Bhd.
- Bluetooth® is a registered trademark owned by Bluetooth SIG Inc.
- iPhone® is a registered trademark of Apple Inc.

## 13 Limited Warranty & Disclaimer

### 13.1 Warranty

FOBO Bike 2 comes with a 12 months limited warranty. This Limited Warranty does not cover: 1) products purchased from an unauthorized reseller; 2) products purchased through online auctions; 3) products that are operated in combination with software, peripheral or ancillary equipment such as but not limited to batteries, chargers, adapters, headsets, connector cables, and power supplies ("Ancillary Equipment") not furnished or otherwise certified by Salutica for use with the FOBO products or any damage to the FOBO products or ancillary equipment as a result of such use; 4) damage caused by (a) accident, fire, misuse, neglect, unusual physical or electrical stress, or modification; (b) improper or unauthorized installation, wiring, repair, testing or (c) use of the product outside Salutica's published guidelines; 5) instances in which someone other than Salutica (or its authorized service centers) tests, alters, modifies or services the products in any way; 6) products that have (a) serial numbers or date tags that have been removed or altered, or (b) nonconforming or non-FOBO housings or parts; and 7) consumable spare parts and accessories (unless they are found to be non-functional or broken upon purchase of product).

In order to obtain any warranty service, you agree to bear all shipping charges of the FOBO Bike 2 device to Salutica's address.

## **13.2 Disclaimer**

SALUTICA MAKES NO OTHER EXPRESS WARRANTY WHETHER WRITTEN OR ORAL AND SALUTICA EXPRESSLY DISCLAIMS ALL WARRANTIES AND CONDITIONS NOT STATED IN THIS LIMITED WARRANTY. TO THE EXTENT ALLOWED BY THE LOCAL LAW OF JURISDICTIONS OUTSIDE MALAYSIA, SALUTICA DISCLAIMS ALL IMPLIED WARRANTIES OR CONDITIONS, INCLUDING ANY IMPLIED WARRANTIES OF MERCHANTABILITY AND FITNESS FOR A PARTICULAR PURPOSE. FOR ALL TRANSACTIONS OCCURRING IN MALAYSIA, ANY IMPLIED WARRANTY OR CONDITION OF MERCHANTABILITY, SATISFACTORY QUALITY, OR FITNESS FOR A PARTICULAR PURPOSE IS LIMITED TO THE WARRANTY PERIOD AS PROVIDED BY SALUTICA IN THE MATERIALS RECEIVED AT THE TIME OF PURCHASE.

No warranty is made that the software provided by Salutica will meet your requirements or will work in combination with any hardware or Applications software products provided by third parties, that the operation of the software products will be uninterrupted or error free, or that all defects in the software products will be corrected.

## **13.3 Limitation of Liability**

THE MAXIMUM LIABILITY OF SALUTICA UNDER THIS LIMITED WARRANTY IS EXPRESSLY LIMITED TO THE LESSER OF THE PRICE YOU HAVE PAID FOR THE PRODUCT OR THE COST OF REPAIR OR REPLACEMENT OF THAT PRODUCT OR ANY COMPONENT OR PART THAT MALFUNCTION IN CONDITIONS OF NORMAL USE. EXCEPT AS INDICATED ABOVE, IN NO EVENT WILL SALUTICA BE LIABLE FOR ANY DAMAGES CAUSED BY THE FOBO BIKE PRODUCT OR THE FAILURE OF THE PRODUCT TO PERFORM, INCLUDING ANY LOST PROFITS OR SAVINGS OR SPECIAL, INCIDENTAL, OR CONSEQUENTIAL DAMAGES. SALUTICA IS NOT LIABLE FOR ANY CLAIM MADE BY A THIRD PARTY OR MADE BY YOU FOR A THIRD PARTY. THIS LIMITATION OF LIABILITY APPLIES WHETHER DAMAGES ARE SOUGHT, OR A CLAIM MADE, UNDER THIS LIMITED WARRANTY OR AS A TORT CLAIM (INCLUDING NEGLIGENCE AND STRICT PRODUCT LIABILITY), A CONTRACT CLAIM, OR ANY OTHER CLAIM. THIS LIMITATION OF LIABILITY CANNOT BE WAIVED OR AMENDED BY ANY PERSON. THIS LIMITATION OF LIABILITY WILL BE EFFECTIVE EVEN IF YOU HAVE ADVISED SALUTICA OR AN AUTHORIZED REPRESENTATIVE OF SALUTICA OF THE POSSIBILITY OF ANY SUCH DAMAGES. THIS LIMITATION OF LIABILITY, HOWEVER,

WILL NOT APPLY TO CLAIMS FOR PERSONAL INJURY.

### **13.4 What Law Governs This Warranty**

THIS LIMITED WARRANTY IS GOVERNED BY AND CONSTRUED UNDER THE LAWS OF MALAYSIA.